

FEATURES

- Eight Independent PSE Channels
- Compliant with IEEE 802.3at Type 1 and 2
- Chipset Provides Electrical Isolation
 - Reduced BOM Cost
 - Eliminates up to 6 High Speed Opto-Couplers
 - Eliminates Isolated 3.3V Power Supply
- Low Power Dissipation
 - 0.25Ω Sense Resistance Per Channel
- Very High Reliability 4-Point PD Detection
 - 2-Point Forced Voltage
 - 2-Point Forced Current
- V_{EE} and V_{PORT} Monitoring
- 1 Second Rolling I_{PORT} Averaging
- Supports 2-Pair and 4-Pair Output Power
- 1MHz I²C Compatible Serial Control Interface
- Available In Three Power Grades
 - A-Grade – LTPoE++™ 38.7W to 90W
 - B-Grade – PoE+ 25.5W
 - C-Grade – PoE 13W
- Available In a 40-Lead 6mm × 6mm (LTC4290) and 24-Lead 4mm × 4mm (LTC4271) QFN Package

APPLICATIONS

- PoE PSE Switches/Routers
- PoE PSE Midspans

DESCRIPTION

The **LTC[®]4290/LTC4271** chipset is an 8-port power sourcing equipment (PSE) controller designed for use in IEEE 802.3at Type 1 and Type 2 (high power) compliant Power over Ethernet (PoE) systems. Transformer-isolated communication protocol replaces expensive opto-couplers and complex isolated 3.3V supply resulting in significant BOM cost savings. The LTC4290/LTC4271 chipset delivers lowest-in-industry heat dissipation by utilizing low-R_{DS(ON)} external MOSFETs and 0.25Ω sense resistors.

Advanced power management features include per-port 12-bit current monitoring ADCs, DAC-programmable current limit, and versatile fast shut-down of preselected ports. Advanced power management host software is available under a no-cost license. PD discovery uses a proprietary dual-mode 4-point detection mechanism ensuring excellent immunity from false PD detection. Midspan PSEs are supported with 2-event classification and a 2 second backoff timer. The LTC4290/LTC4271 includes an I²C serial interface operable up to 1MHz.

The LTC4290/LTC4271 is available in multiple power grades allowing delivered PD power up to 90W.

LT, LT, LTC, LTM, Burst Mode, Linear Technology and the Linear logo are registered trademarks and LTPoE++ is a trademark of Linear Technology Corporation. All other trademarks are the property of their respective owners.

TYPICAL APPLICATION

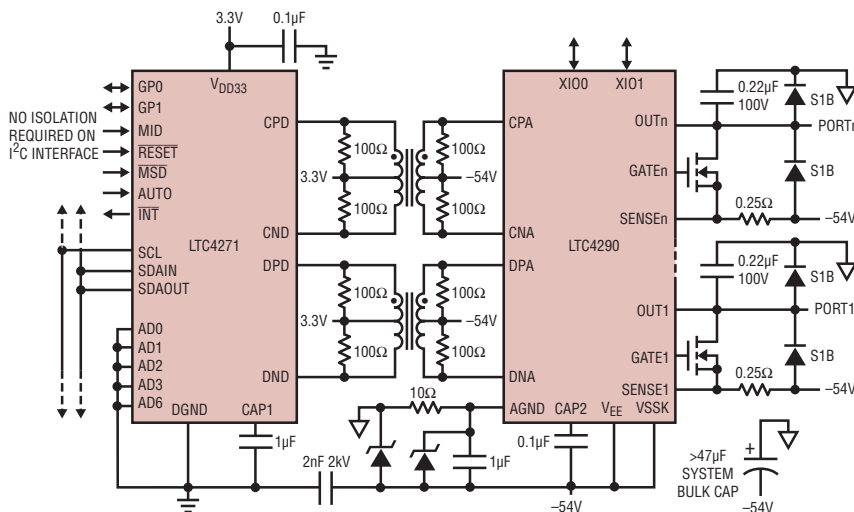

LTC4290/LTC4271 FAMILY

LTC4290 GRADE	ISOLATION	LTPoE++	PoE+	PoE	MAX DELIVERED POWER
A	Transformer	●	●	●	90W
B	Transformer		●	●	25.5W
C	Transformer			●	13W

ABSOLUTE MAXIMUM RATINGS

(Notes 1, 4)

LTC4290

Supply Voltages

AGND – V_{EE} –0.3V to 80V

VSSK (Note 7) V_{EE} – 0.3V to V_{EE} + 0.3V

Digital Pins

XIO_n V_{EE} – 0.3V to CAP2 + 0.3V

Analog Pins

SENSE_n, GATE_n, OUT_n V_{EE} – 0.3V to V_{EE} + 80V

CAP2 (Note 13) V_{EE} – 0.3V to V_{EE} + 5V

CPA, CNA, DPA, DNA V_{EE} – 0.3V to V_{EE} + 0.3

Operating Ambient Temperature Range

LTC4290I –40°C to 85°C

Junction Temperature (Note 2) 125°C

Storage Temperature Range –65°C to 150°C

(Note 1)

LTC4271

Supply Voltages

V_{DD} – DGND –0.3V to 3.6V

Digital Pins

SCL, SDA_{IN}, SDA_{OUT}, $\overline{\text{INT}}$, $\overline{\text{RESET}}$, $\overline{\text{MSD}}$, AD_n, AUTO,

MID, GP_n DGND – 0.3V to V_{DD} + 0.3V

Analog Pins

CAP1 (Note 13) –0.3V to DGND + 2V

CPD, CND, DPD, DND DGND – 0.3V to V_{DD} + 0.3V

Operating Ambient Temperature Range

LTC4271I –40°C to 85°C

Junction Temperature (Note 2) 125°C

Storage Temperature Range –65°C to 150°C

PIN CONFIGURATION

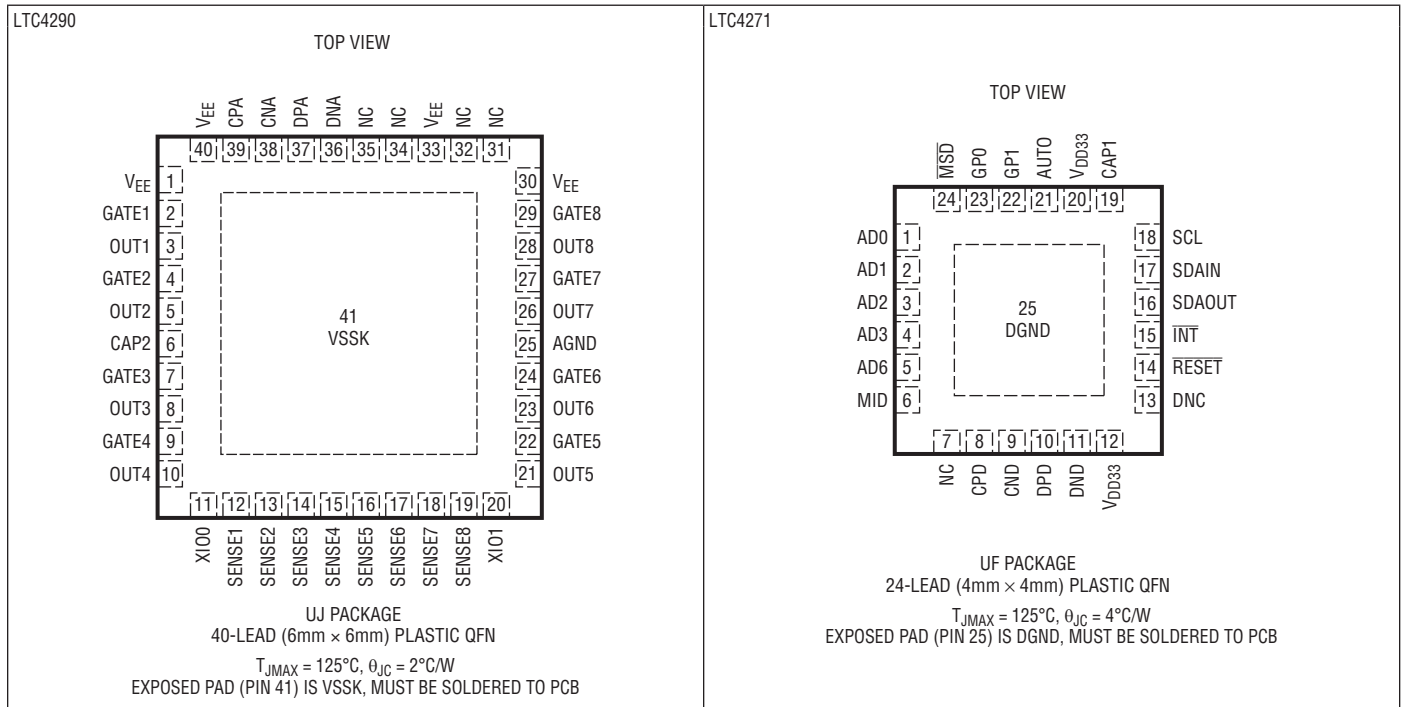

ORDER INFORMATION

LEAD FREE FINISH	TAPE AND REEL	PART MARKING	PACKAGE DESCRIPTION	MAX PWR	TEMPERATURE RANGE
LTC4271IUF#PBF	LTC4271IUF#TRPBF	4271	24-Lead (4mm × 4mm) Plastic QFN		-40°C to 85°C
LTC4290AIUJ#PBF	LTC4290AIUJ#TRPBF	LTC4290AUJ	40-Lead (6mm × 6mm) Plastic QFN	90W	-40°C to 85°C
LTC4290BIUJ#PBF	LTC4290BIUJ#TRPBF	LTC4290BUJ	40-Lead (6mm × 6mm) Plastic QFN	25.5W	-40°C to 85°C
LTC4290CIUJ#PBF	LTC4290CIUJ#TRPBF	LTC4290CUJ	40-Lead (6mm × 6mm) Plastic QFN	13W	-40°C to 85°C

Consult LTC Marketing for parts specified with wider operating temperature ranges.

Consult LTC Marketing for information on non-standard lead based finish parts.

For more information on lead free part marking, go to: <http://www.linear.com/leadfree/>

For more information on tape and reel specifications, go to: <http://www.linear.com/tapeandreel/>

ELECTRICAL CHARACTERISTICS

The ● denotes the specifications which apply over the full operating temperature range, otherwise specifications are at $T_A = 25^\circ\text{C}$. $\text{AGND} - V_{EE} = 54\text{V}$ and $V_{DD} - \text{DGND} = 3.3\text{V}$ unless otherwise noted. (Notes 3 & 4)

SYMBOL	PARAMETER	CONDITIONS	MIN	TYP	MAX	UNITS	
V_{EE}	Main PoE Supply Voltage	$\text{AGND} - V_{EE}$	●	45	57	V	
		For IEEE Type 1 Compliant Output	●	51	57	V	
		For LTPoE++ Compliant Output	●	54.75	57	V	
	Undervoltage Lock-Out	$\text{AGND} - V_{EE}$	●	20	25	30	V
V_{DD}	V_{DD} Supply Voltage	$V_{DD} - \text{DGND}$	●	3.0	3.3	3.6	V
	Undervoltage Lock-Out	$V_{DD} - \text{DGND}$			2.7		V
V_{CAP1}	Internal Regulator Supply Voltage	$V_{CAP1} - \text{DGND}$			1.84	V	
V_{CAP2}	Internal Regulator Supply Voltage	$V_{CAP2} - V_{EE}$			4.3	V	
I_{EE}	V_{EE} Supply Current	$(\text{AGND} - V_{EE}) = 55\text{V}$	●	9	15	mA	
R_{EE}	V_{EE} Supply Resistance	$V_{EE} < 15\text{V}$	●		12	k Ω	
I_{DD}	V_{DD} Supply Current	$(V_{DD} - \text{DGND}) = 3.3\text{V}$	●	10	15	mA	
Detection							
	Detection Current – Forced Current	First Point, $\text{AGND} - V_{OUTn} = 9\text{V}$	●	220	240	260	μA
		Second Point, $\text{AGND} - V_{OUTn} = 3.5\text{V}$	●	143	160	180	μA
	Detection Voltage – Forced Voltage	$\text{AGND} - V_{OUTn}$, $5\mu\text{A} \leq I_{OUTn} \leq 500\mu\text{A}$					
		First Point	●	7	8	9	V
	Second Point	●	3	4	5	V	
	Detection Current Compliance	$\text{AGND} - V_{OUTn} = 0\text{V}$	●	0.8	0.9	mA	
V_{OC}	Detection Voltage Compliance	$\text{AGND} - V_{OUTn}$, Open Port	●	10.4	12	V	
	Detection Voltage Slew Rate	$\text{AGND} - V_{OUTn}$, $C_{PORT} = 0.15\mu\text{F}$	●		0.01	V/ μs	
	Min. Valid Signature Resistance		●	15.5	17	18.5	k Ω
	Max. Valid Signature Resistance		●	27.5	29.7	32	k Ω
Classification							
V_{CLASS}	Classification Voltage	$\text{AGND} - V_{OUTn}$, $0\text{mA} \leq I_{OUTn} \leq 50\text{mA}$	●	16.0	20.5	V	
	Classification Current Compliance	$V_{OUTn} = \text{AGND}$	●	53	61	67	mA
	Classification Threshold Current	Class 0-1	●	5.5	6.5	7.5	mA
		Class 1-2	●	13.5	14.5	15.5	mA
		Class 2-3	●	21.5	23	24.5	mA
		Class 3-4	●	31.5	33	34.9	mA
		Class 4-Overcurrent	●	45.2	48	50.8	mA
V_{MARK}	Classification Mark State Voltage	$\text{AGND} - V_{OUTn}$, $0.1\text{mA} \leq I_{CLASS} \leq 5\text{mA}$	●	7.5	9	10	V
	Mark State Current Compliance	$V_{OUTn} = \text{AGND}$	●	53	61	67	mA
Gate Driver							
	GATE Pin Pull-Down Current	Port Off, $V_{GATEn} = V_{EE} + 5\text{V}$	●	0.4		mA	
		Port Off, $V_{GATEn} = V_{EE} + 1\text{V}$	●	0.08	0.12	mA	
	GATE Pin Fast Pull-Down Current	$V_{GATEn} = V_{EE} + 5\text{V}$			30	mA	
	GATE Pin On Voltage	$V_{GATEn} - V_{EE}$, $I_{GATEn} = 1\mu\text{A}$	●	8	12	14	V
Output Voltage Sense							
V_{PG}	Power Good Threshold Voltage	$V_{OUTn} - V_{EE}$	●	2	2.4	2.8	V
	OUT Pin Pull-Up Resistance to AGND	$0\text{V} \leq (\text{AGND} - V_{OUT}) \leq 5\text{V}$	●	300	500	700	k Ω

ELECTRICAL CHARACTERISTICS The ● denotes the specifications which apply over the full operating temperature range, otherwise specifications are at $T_A = 25^\circ\text{C}$. $AGND - V_{EE} = 54\text{V}$ and $V_{DD} - DGND = 3.3\text{V}$ unless otherwise noted. (Notes 3 & 4)

SYMBOL	PARAMETER	CONDITIONS	MIN	TYP	MAX	UNITS	
V_{CUT}	Overcurrent Sense Voltage	$V_{\text{SENSEn}} - V_{\text{EE}}$, $h_{\text{pen}} = 0\text{Fh}$, $\text{cutn} = \text{D4h}$	● ●	89 152	94 159	99 168	mV mV
		$h_{\text{pen}} = 0\text{Fh}$, $\text{cutn} = \text{E2h}$ (Note 12)	● ● ● ●	89 26 49 152	94 28 52 159	99 30 55 168	mV mV mV mV
V_{LIM}	Active Current Limit in 802.3af Compliant Mode	Class 0, Class 3	● ●	89 26	94 28	99 30	mV mV
		Class 1	●	49	52	55	mV
	Class 2	●	152	159	168	mV	
V_{LIM}	Active Current Limit in High Power Mode	Class 4	● ●	102 25	106 106	112 50	mV mV
		$V_{\text{SENSEn}} - V_{\text{EE}}$, $h_{\text{pen}} = 0\text{Fh}$, $\text{limn} = 80\text{h}$, ($AGND - V_{\text{EE}}$) = 55V $V_{\text{EE}} < V_{\text{OUT}} < AGND - 29\text{V}$ $AGND - V_{\text{OUT}} = 0\text{V}$ (Note 12)	● ●	102 25	106 106	112 50	mV mV
	Active Current Limit in AUTO Pin Mode	$h_{\text{pen}} = 0\text{Fh}$, $\text{limn} = \text{C0h}$, ($AGND - V_{\text{EE}}$) = 55V $V_{\text{OUT}} - V_{\text{EE}} = 0 - 10\text{V}$ $V_{\text{EE}} + 23\text{V} < V_{\text{OUT}} < AGND - 29\text{V}$ $AGND - V_{\text{OUT}} = 0\text{V}$ (Note 12)	● ● ●	204 102 25	212 106 106	225 115 50	mV mV mV
V_{LIM}	Active Current Limit in AUTO Pin Mode	$V_{\text{EE}} < V_{\text{OUT}} < AGND - 10\text{V}$, ($AGND - V_{\text{EE}}$) = 55V Class 0 to Class 3 Class 4	● ●	102 204	106 212	112 225	mV mV
V_{MIN}	DC Disconnect Sense Voltage	$V_{\text{SENSE}} - V_{\text{EE}}$, $\text{rdis Bit} = 0$	●	2.6	3.8	4.9	mV
		$V_{\text{SENSE}} - V_{\text{EE}}$, $\text{rdis Bit} = 1$ (Note 12)	●	1.3	1.9	2.45	mV
V_{SC}	Short-Circuit Sense	$V_{\text{SENSEn}} - V_{\text{EE}} - V_{\text{LIM}}$ (Note 12)	●	125	200	255	mV
		$\text{rdis Bit} = 0$ $\text{rdis Bit} = 1$	● ●	70	100	125	mV

Port Current Readback

Resolution	No Missing Codes, Reported as 14 Bits	12	Bits
LSB Weight	$V_{\text{SENSEn}} - V_{\text{EE}}$	30.518	$\mu\text{V}/\text{LSB}$
Conversion Period		25.1	ms/ Convert

Port Voltage Readback

Resolution	No Missing Codes, Reported as 14 Bits	12	Bits
LSB Weight	$AGND - V_{\text{OUTn}}$	5.8350	mV/LSB

Digital Interface

V_{ILD}	Digital Input Low Voltage	ADn , $\overline{\text{RESET}}$, $\overline{\text{MSD}}$, GPn , AUTO, MID (Note 6)	●	0.8	V
	I ² C Input Low Voltage	SCL, SDA _{IN} (Note 6)	●	1.0	V
V_{IHD}	Digital Input High Voltage	(Note 6)	●	2.2	V
	Digital Output Voltage Low	$I_{\text{SDAOUT}} = 3\text{mA}$, $I_{\text{INT}} = 3\text{mA}$ $I_{\text{SDAOUT}} = 5\text{mA}$, $I_{\text{INT}} = 5\text{mA}$	● ●	0.4 0.7	V V
	Internal Pull Up to V_{DD}	ADn , $\overline{\text{RESET}}$, $\overline{\text{MSD}}$, GPn		50	$k\Omega$
	Internal Pull Down To DGND	AUTO, MID		50	$k\Omega$

LTC4290/LTC4271

ELECTRICAL CHARACTERISTICS The ● denotes the specifications which apply over the full operating temperature range, otherwise specifications are at $T_A = 25^\circ\text{C}$. $\text{AGND} - V_{EE} = 54\text{V}$ and $V_{DD} - \text{DGND} = 3.3\text{V}$ unless otherwise noted. (Notes 3 & 4)

SYMBOL	PARAMETER	CONDITIONS	MIN	TYP	MAX	UNITS
XIO						
V_{OLX}	XIO Digital Output Low	$V_{XIO_n} - V_{EE}$, $I_{XIO_n} = 5\text{mA}$	●		0.7	V
V_{OHX}	XIO Digital Output High	$V_{XIO_n} - V_{EE}$, $I_{XIO_n} = 100\mu\text{A}$	●	3.5		V
	XIO Digital Input Low Voltage	$V_{XIO_n} - V_{EE}$	●		0.8	V
	XIO Digital Input High Voltage	$V_{XIO_n} - V_{EE}$	●	3.4		V
	Internal Pull Up to CAP2	X100, XIO1		50		k Ω

PSE Timing Characteristics

t_{DET}	Detection Time	Beginning To End of Detection (Note 7)		220		ms	
t_{CLE}	Class Event Duration	(Note 7)		12		ms	
t_{CLEON}	Class Event Turn On Duration	$C_{PORT} = 0.6\mu\text{F}$ (Note 7)	●		0.1	ms	
t_{ME}	Mark Event Duration	(Note 7, Note 11)		8.6		ms	
t_{MEL}	Last Mark Event Duration	(Note 7, Note 11)	●	16	22	ms	
t_{PON}	Power On Delay in AUTO Pin Mode	From End of Valid Detect to Application of Power to Port (Note 7)	●		60	ms	
	Turn-On Rise Time	($\text{AGND} - V_{OUT}$): 10% to 90% of ($\text{AGND} - V_{EE}$) $C_{PORT} = 0.15\mu\text{F}$ (Note 7)	●	15	24	μs	
	Turn-On Ramp Rate	$C_{PORT} = 0.15\mu\text{F}$ (Note 7)	●		10	V/ μs	
t_{TOCL}	Turn-On Class Transition	$C_{PORT} = 0.15\mu\text{F}$ (Note 7)	●		0.1	ms	
t_{ED}	Fault Delay	From I_{CUT} or I_{LIM} Fault to Next Detect (Note 7)	●	1.0	1.1	s	
	Midspan Mode Detection Backoff	$R_{PORT} = 15.5\text{k}\Omega$ (Note 7)	●	2.3	2.5	2.7	s
	Power Removal Detection Delay	From Power Removal After t_{DIS} to Next Detect (Note 7)	●	1.0	1.3	2.5	s
t_{START}	Maximum Current Limit Duration During Port Start-Up	(Note 7)	●	52	59	66	ms
t_{CUT}	Maximum Overcurrent Duration After Port Start-Up	(Note 7)	●	52	59	66	ms
	Maximum Overcurrent Duty Cycle	(Note 7)	●	5.8	6.3	6.7	%
t_{LIM}	Maximum Current Limit Duration After Port Start-Up – t_{LIM} Enabled	$t_{LIM} = 1$ (Note 7, Note 12)	●	10	12	14	ms
	Maximum Current Limit Duration After Port Start-Up – t_{LIM} as t_{CUT}	$t_{LIM} = 0$ (Note 7, Note 12)	●	52	59	66	ms
t_{MPS}	Maintain Power Signature (MPS) Pulse Width Sensitivity	Current Pulse Width to Reset Disconnect Timer (Note 7, Note 8)	●	1.6		3.6	ms
t_{DIS}	Maintain Power Signature (MPS) Dropout Time	(Note 7, Note 5)	●	320	350	380	ms
t_{MSD}	Masked Shut Down Delay	(Note 7)			6.5	μs	
	I ² C Watchdog Timer Duration	(Note 7)	●	1.5	2	3	s
	Minimum Pulse Width for Masked Shut Down	(Note 7)	●	3		μs	
	Minimum Pulse Width for RESET	(Note 7)	●	4.5		μs	

ELECTRICAL CHARACTERISTICS

The ● denotes the specifications which apply over the full operating temperature range, otherwise specifications are at $T_A = 25^\circ\text{C}$. $AGND - V_{EE} = 54\text{V}$ and $V_{DD} - DGND = 3.3\text{V}$ unless otherwise noted. (Notes 3 & 4)

SYMBOL	PARAMETER	CONDITIONS		MIN	TYP	MAX	UNITS
I²C Timing							
f_{SCLK}	Clock Frequency	(Note 7)	●			1	MHz
t_1	Bus Free Time	Figure 5 (Notes 7, 9)	●	480			ns
t_2	Start Hold Time	Figure 5 (Notes 7, 9)	●	240			ns
t_3	SCL Low Time	Figure 5 (Notes 7, 9)	●	480			ns
t_4	SCL High Time	Figure 5 (Notes 7, 9)	●	240			ns
t_5	SDAIN Data Hold Time	Figure 5 (Notes 7, 9)	●	60			ns
t_5	Data Clock to SDAOUT Valid	Figure 5 (Notes 7, 9)	●			130	ns
t_6	Data Set-Up Time	Figure 5 (Notes 7, 9)	●	80			ns
t_7	Start Set-Up Time	Figure 5 (Notes 7, 9)	●	240			ns
t_8	Stop Set-Up Time	Figure 5 (Notes 7, 9)	●	240			ns
t_r	SCL, SDAIN Rise Time	Figure 5 (Notes 7, 9)	●			120	ns
t_f	SCL, SDAIN Fall Time	Figure 5 (Notes 7, 9)	●			60	ns
	Fault Present to $\overline{\text{INT}}$ Pin Low	(Notes 7, 9, 10)	●			150	ns
	Stop Condition to $\overline{\text{INT}}$ Pin Low	(Notes 7, 9, 10)	●			1.5	μs
	ARA to $\overline{\text{INT}}$ Pin High Time	(Notes 7, 9)	●			1.5	μs
	SCL Fall to ACK Low	(Notes 7, 9)	●			130	ns

Note 1: Stresses beyond those listed under Absolute Maximum Ratings may cause permanent damage to the device. With the exception of ($V_{DD} - DGND$), exposure to any Absolute Maximum Rating condition for extended periods may affect device reliability and lifetime.

Note 2: This IC includes overtemperature protection that is intended to protect the device during momentary overload conditions. Junction temperature will exceed 140°C when overtemperature protection is active. Continuous operation above the specified maximum operating junction temperature may impair device reliability.

Note 3: All currents into device pins are positive; all currents out of device pins are negative.

Note 4: The LTC4290 operates with a negative supply voltage (with respect to AGND). To avoid confusion, voltages in this data sheet are referred to in terms of absolute magnitude.

Note 5: t_{DJS} is the same as t_{MPD0} defined by IEEE 802.3

Note 6: The LTC4271 digital interface operates with respect to DGND. All logic levels are measured with respect to DGND.

Note 7: Guaranteed by design, not subject to test.

Note 8: The IEEE 802.3 specification allows a PD to present its Maintain Power Signature (MPS) on an intermittent basis without being disconnected. In order to stay powered, the PD must present the MPS for t_{MPS} within any t_{MPD0} time window.

Note 9: Values Measured at V_{ILD} and V_{IHD}

Note 10: If a fault condition occurs during an I²C transaction, the $\overline{\text{INT}}$ pin will not be pulled down until a stop condition is present on the I²C bus.

Note 11: Load characteristics of the LTC4290 during Mark: $7\text{V} < (AGND - V_{\text{OUTn}}) < 10\text{V}$ or $I_{\text{OUT}} < 50\mu\text{A}$.

Note 12: See the LTC4271 Software Programming documentation for information on serial bus usage and device configuration and status registers.

Note 13: Do not source or sink current from CAP1 and CAP2.

TYPICAL PERFORMANCE CHARACTERISTICS

802.3af Power On Sequence in AUTO Pin Mode

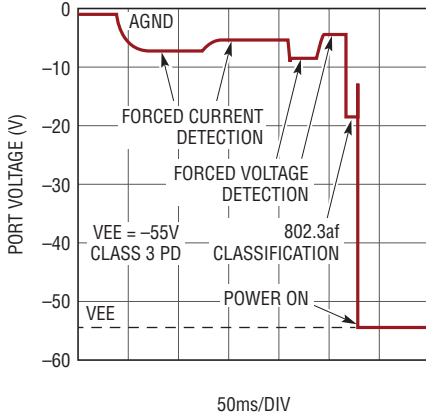

429071 G01

802.3at Power On Sequence in AUTO Pin Mode

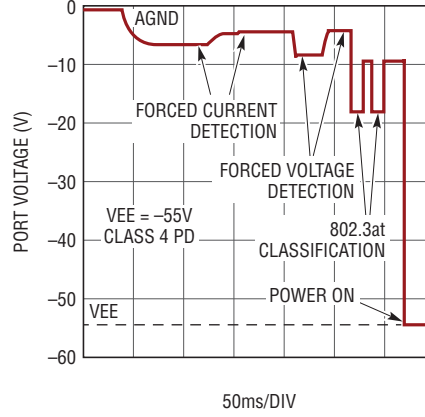

429071 G02

Power On Sequence with 10Vpp 60Hz Noise

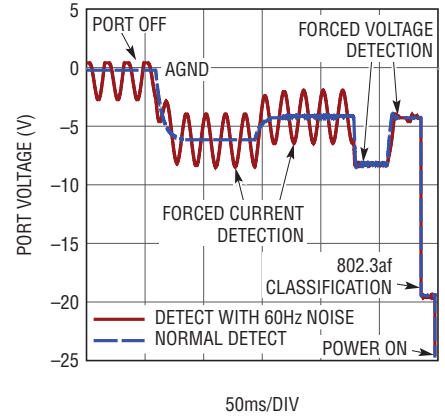

429071 G03

Powering Up into a 180µF Load

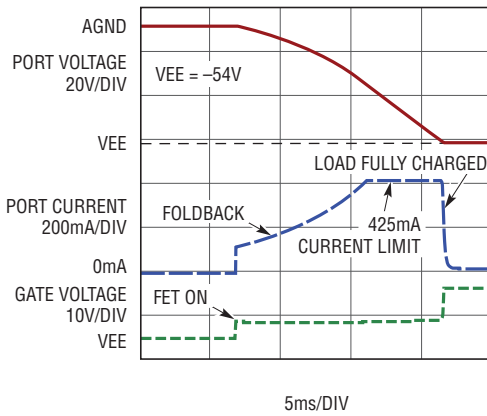

429071 G04

Classification Transient Response to 40mA Load Step

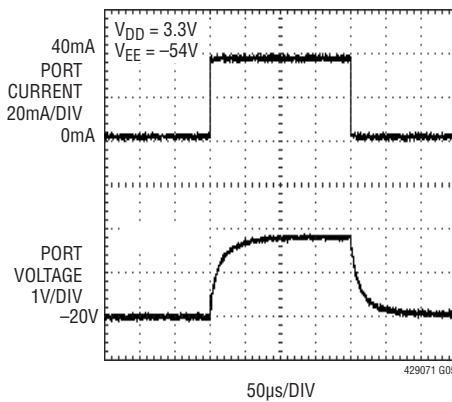

429071 G05

Classification Current Compliance

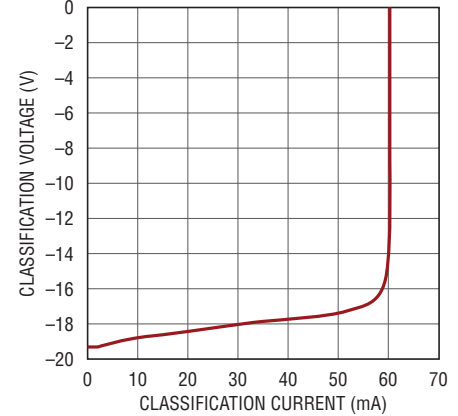

429071 G06

V_{DD} Supply Current vs Voltage

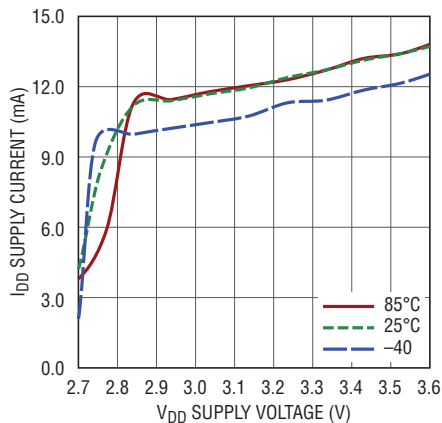

429071 G07

V_{EE} Supply Current vs Voltage

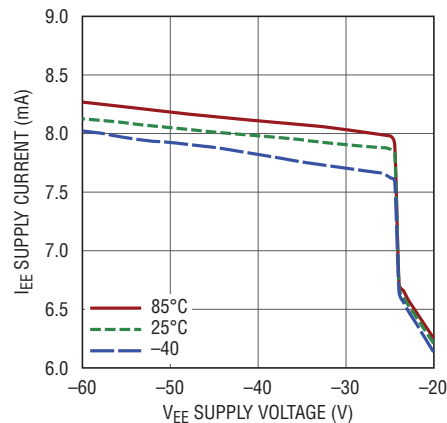

429071 G08

TYPICAL PERFORMANCE CHARACTERISTICS

802.3at I_{LIM} Threshold vs Temperature

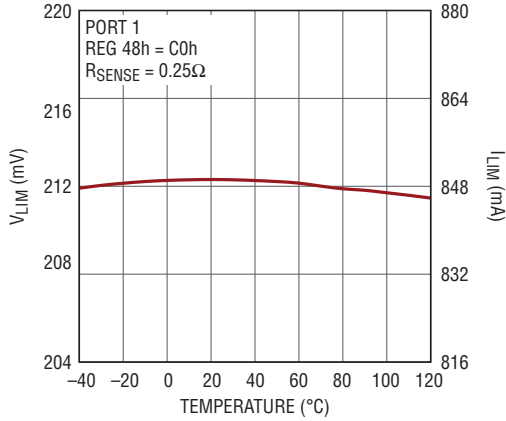

429071 G09

802.3at I_{CUT} Threshold vs Temperature

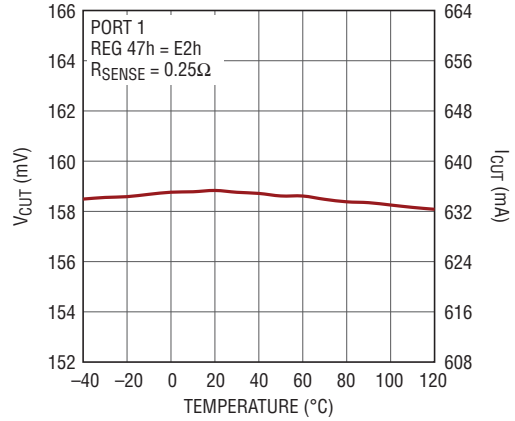

429071 G10

DC Disconnect Threshold vs Temperature

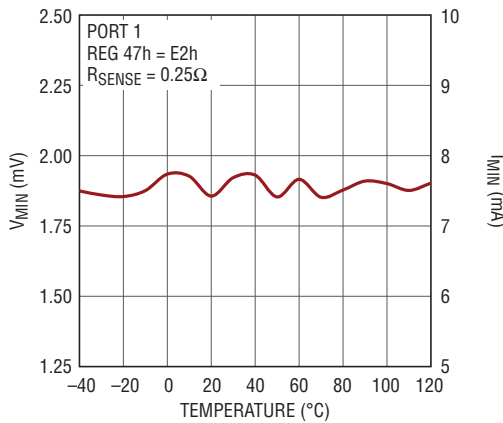

429071 G11

802.3at Current Limit Foldback

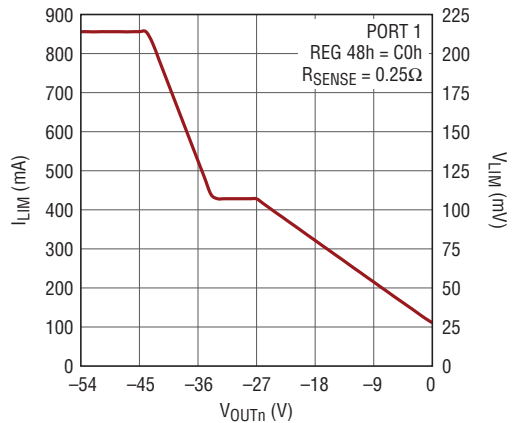

429071 G12

\overline{INT} and SDAOUT Pull Down Voltage vs Load Current

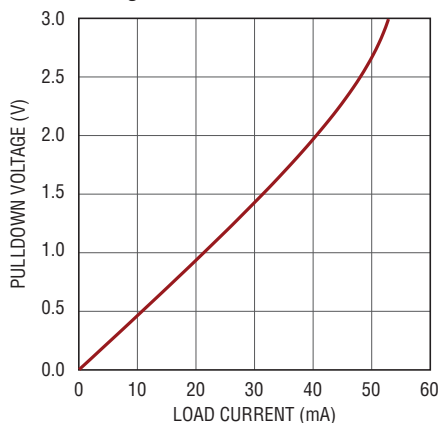

429071 G13

MOSFET Gate Drive With Fast Pull Down

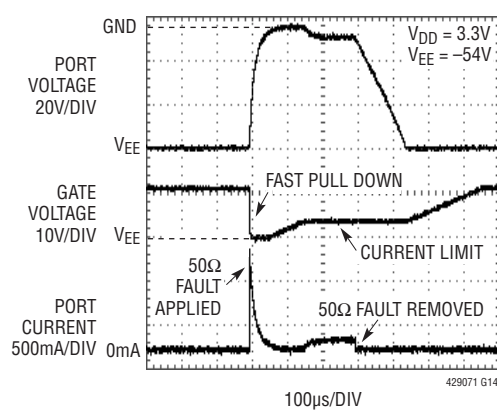

429071 G14

TEST TIMING DIAGRAMS

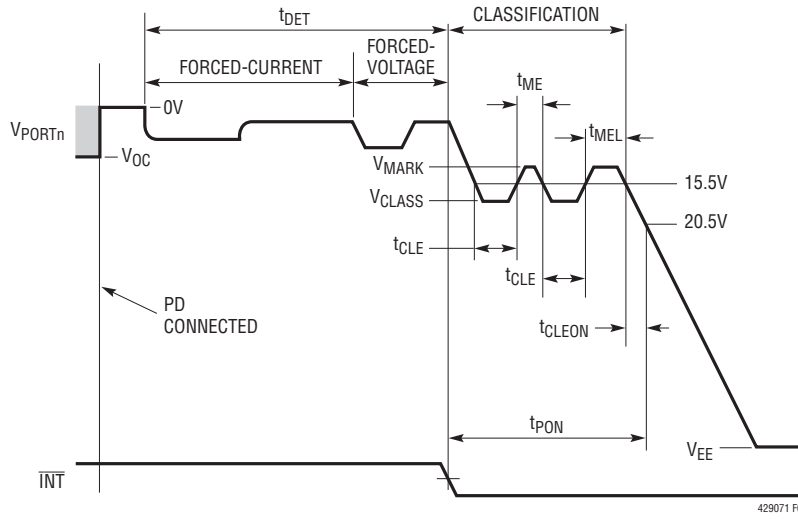

Figure 1. Detect, Class and Turn-On Timing in AUTO Pin or Semi-auto Modes

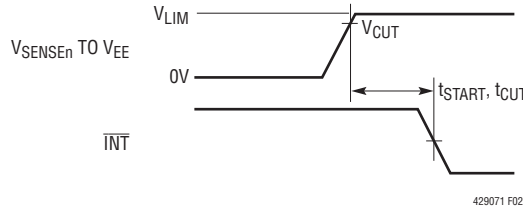

Figure 2. Current Limit Timing

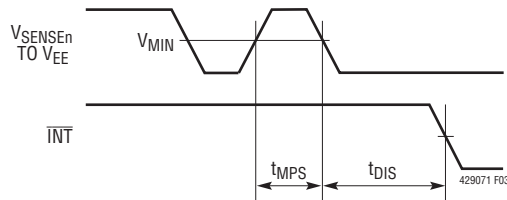

Figure 3. DC Disconnect Timing

TEST TIMING DIAGRAMS

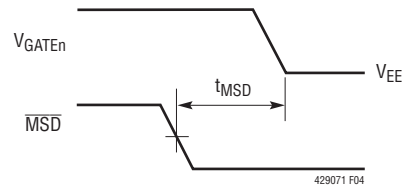

Figure 4. Shut Down Delay Timing

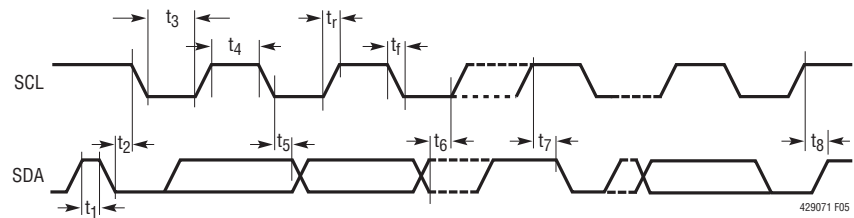

Figure 5. I²C Interface Timing

I²C TIMING DIAGRAMS

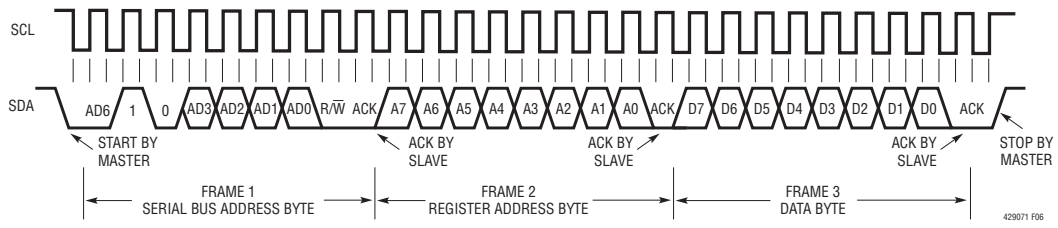

Figure 6. Writing to a Register

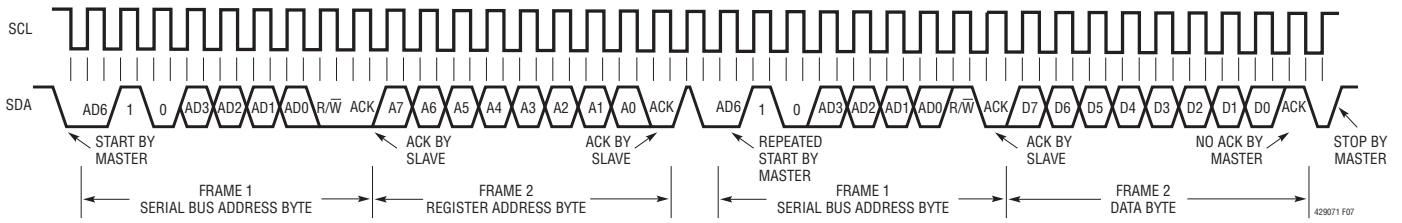

Figure 7. Reading from a Register

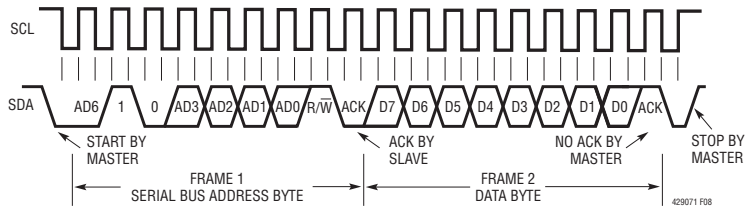

Figure 8. Reading the Interrupt Register (Short Form)

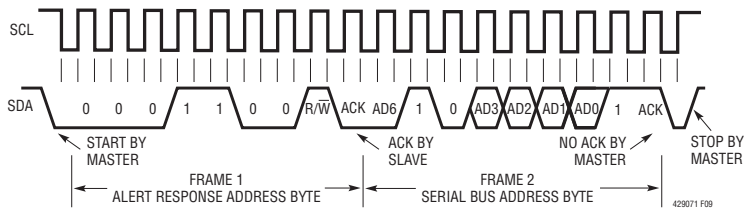

Figure 9. Reading from Alert Response Address

PIN FUNCTIONS

LTC4290

V_{EE} (Pins 1, 30, 33, 40): Main PoE Supply Input. Connect to a -45V to -57V supply, relative to AGND. Voltage depends on PSE type (Type 1, Type 2 or LT_{POE++}).

GATEn (Pins 2, 4, 7, 9, 22, 24, 27, 29): Port n Gate Drive. GATEn should be connected to the gate of the external MOSFET for port n. When the MOSFET is turned on, the gate voltage is driven to 12V (typ) above V_{EE}. During a current limit condition, the voltage at GATEn will be reduced to maintain constant current through the external MOSFET. If the fault timer expires, GATEn is pulled down, turning the MOSFET off and recording a port fault event. If the port is unused, float the GATEn pin.

OUTn (Pins 3, 5, 8, 10, 21, 23, 26, 28): Port n Output Voltage Monitor. OUTn should be connected to the output port. A current limit foldback circuit limits the power dissipation in the external MOSFET by reducing the current limit threshold when the drain-to-source voltage exceeds 10V. The port n Power Good bit is set when the voltage from OUTn to V_{EE} drops below 2.4V (typ). A 500k resistor is connected internally from OUTn to AGND when the port is idle. If the port is unused, the OUTn pin must be floated.

CAP2 (Pin 6): Analog Internal 4.3V Power Supply Bypass Capacitor. Connect 0.1μF ceramic cap to V_{EE}.

XI00 (Pin 11): General Purpose Digital Input Output. Logic signal between V_{EE} and V_{EE} + 4.3V. Internal pull up.

SENSEn (Pins 12, 13, 14, 15, 16, 17, 18, 19): Port n Current Sense Input. SENSEn monitors the external MOSFET current via a 0.5Ω or 0.25Ω sense resistor between SENSEn and V_{EE}. Whenever the voltage across the sense resistor exceeds the overcurrent detection threshold V_{CUT}, the current limit fault timer counts up. If the voltage across the sense resistor reaches the current limit threshold V_{LIM}, the GATEn pin voltage is lowered to maintain constant current in the external MOSFET. See Applications Information for further details. If the port is unused, the SENSEn pin must be tied to V_{EE}.

XI01 (Pin 20): General Purpose Digital Input Output. Logic signal between V_{EE} and V_{EE} + 4.3V. Internal pull up.

AGND (Pin 25): Analog Ground. Connect AGND to the return for the V_{EE} supply.

DNA (Pin 36): Data Transceiver Negative Input Output (Analog). Connect to DND through a data transformer.

DPA (Pin 37): Data Transceiver Positive Input Output (Analog). Connect to DPD through a data transformer.

CNA (Pin 38): Clock Transceiver Negative Input Output (Analog). Connect to CND through a data transformer.

CPA (Pin 39): Clock Transceiver Positive Input Output (Analog). Connect to CPD through a data transformer.

VSSK (Exposed Pad Pin 41): Kelvin Sense to V_{EE}. Connect to sense resistor common node. Do not connect directly to V_{EE} plane. See Layout Guide.

Common Pins

NC, DNC (LTC4271 Pins 7, 13; LTC4290 Pins 31, 32, 34, 35): All pins identified with “NC” or “DNC” must be left unconnected.

LTC4271

AD0 (Pin 1): Address Bit 0. Tie the address pins high or low to set the starting I²C serial address to which the LTC4271 responds. The chip will respond to this address plus the next two incremental addresses. The base address of the first four ports will be (A₆10A₃A₂A₁A₀)b. The second and third groups of four ports will respond at the next two logical addresses. Internally pulled up to V_{DD}.

AD1 (Pin 2): Address Bit 1. See AD0.

AD2 (Pin 3): Address Bit 2. See AD0.

AD3 (Pin 4): Address Bit 3. See AD0.

AD6 (Pin 5): Address Bit 6. See AD0.

MID (Pin 6): Midspan Mode Input. When high, the LTC4271 acts as a midspan device. Internally pulled down to DGND.

CPD (Pin 8): Clock Transceiver Positive Input Output (Digital). Connect to CPA through a data transformer.

PIN FUNCTIONS

CND (Pin 9): Clock Transceiver Negative Input Output (Digital). Connect to CNA through a data transformer.

DPD (Pin 10): Data Transceiver Positive Input Output (Digital). Connect to DPA through a data transformer.

DND (Pin 11): Data Transceiver Negative Input Output (Digital). Connect to DNA through a data transformer.

V_{DD33} (Pins 12, 20): V_{DD} IO Power Supply. Connect to a 3.3V power supply relative to DGND. V_{DD33} must be bypassed to DGND near the LTC4271 with at least a 0.1μF capacitor.

RESET (Pin 14): Reset Input, Active Low. When the $\overline{\text{RESET}}$ pin is low, the LTC4290/LTC4271 is held inactive with all ports off and all internal registers reset to their power-up states. When $\overline{\text{RESET}}$ is pulled high, the LTC4271 begins normal operation. $\overline{\text{RESET}}$ can be connected to an external capacitor or RC network to provide a power turn-on delay. Internal filtering of the $\overline{\text{RESET}}$ pin prevents glitches less than 1μs wide from resetting the LTC4290/LTC4271. Internally pulled up to V_{DD}.

$\overline{\text{INT}}$ (Pin 15): Interrupt Output, Open Drain. $\overline{\text{INT}}$ will pull low when any one of several events occur in the LTC4271. It will return to a high impedance state when bits 6 or 7 are set in the Reset PB register (1Ah). The $\overline{\text{INT}}$ signal can be used to generate an interrupt to the host processor, eliminating the need for continuous software polling. Individual $\overline{\text{INT}}$ events can be disabled using the $\overline{\text{INT}}$ Mask register (01h). See LTC4271 Software Programming documentation for more information. The $\overline{\text{INT}}$ pin is only updated between I²C transactions.

SDAOUT (Pin 16): Serial Data Output, Open Drain Data Output for the I²C Serial Interface Bus. The LTC4271 uses two pins to implement the bidirectional SDA function to simplify optoisolation of the I²C bus. To implement a standard bidirectional SDA pin, tie SDAOUT and SDAIN together. See Applications Information for more information.

SDAIN (Pin 17): Serial Data Input. High impedance data input for the I²C serial interface bus. The LTC4271 uses two pins to implement the bidirectional SDA function to simplify optoisolation of the I²C bus. To implement a standard bidirectional SDA pin, tie SDAOUT and SDAIN together. See Applications Information for more information.

SCL (Pin 18): Serial Clock Input. High impedance clock input for the I²C serial interface bus. The SCL pin should be connected directly to the I²C SCL bus line. SCL must be tied high if the I²C serial interface bus is not used.

CAP1 (Pin 19): Core Power Supply Bypass Capacitor. Connect a 1μF Bypass capacitance to DGND for the internal 1.8V regulator. Do not use other capacitor values.

AUTO (Pin 21): AUTO Pin Mode Input. AUTO pin mode allows the LTC4271 to detect and power up a PD even if there is no host controller present on the I²C bus. The AUTO pin determines the state of the internal registers when the LTC4271 is reset or comes out of V_{DD} UVLO (see LTC4271 Software Programming documentation). The states of these register bits can subsequently be changed via the I²C interface. Internally pulled down to DGND. Must be tied locally to either V_{DD} or DGND.

GP1 (Pin 22): General Purpose Digital Input Output for customer applications. Referenced to DGND.

GP0 (Pin 23): General Purpose Digital Input Output for customer applications. Referenced to DGND.

$\overline{\text{MSD}}$ (Pin 24): Maskable Shutdown Input. Active low. When pulled low, all ports that have their corresponding mask bit set in the mconfig register (17h) will be reset. Internal filtering of the $\overline{\text{MSD}}$ pin prevents glitches less than 1μs wide from resetting ports. The MSD Pin Mode register can configure the $\overline{\text{MSD}}$ pin polarity. Internally pulled up to V_{DD}.

DGND (Exposed Pad Pin 25): Digital Ground. DGND should be connected to the return from the V_{DD} supply.

APPLICATIONS INFORMATION

OVERVIEW

Power over Ethernet, or PoE, is a standard protocol for sending DC power over copper Ethernet data wiring. The IEEE group that administers the 802.3 Ethernet data standards added PoE powering capability in 2003. This original PoE spec, known as 802.3af, allowed for 48V DC power at up to 13W. This initial specification was widely popular, but 13W was not adequate for some requirements. In 2009, the IEEE released a new standard, known as 802.3at or PoE+, increasing the voltage and current requirements to provide 25W of power.

The IEEE standard also defines PoE terminology. A device that provides power to the network is known as a PSE, or power sourcing equipment, while a device that draws power from the network is known as a PD, or powered device. PSEs come in two types: Endpoints (typically network switches or routers), which provide data and power; and Midspans, which provide power but pass through data. Midspans are typically used to add PoE capability to existing non-PoE networks. PDs are typically IP phones, wireless access points, security cameras, and similar devices.

PoE++ Evolution

Even during the process of creating the IEEE PoE+ 25.5W specification it became clear that there was a significant and increasing need for more than 25.5W of delivered power. The A-grade LTC4290/LTC4271 chipset responds to this market by allowing a reliable means of providing up to 90W of delivered power to a LTPoE++ PD. The LTPoE++ specification provides reliable detection and classification extensions to the existing IEEE PoE protocols that are backward compatible and interoperable with existing Type 1 and Type 2 PDs. Unlike other proprietary PoE++ solutions Linear's LTPoE++ provides mutual identification between the PSE and PD. This ensures the LTPoE++ PD knows it may use the requested power at start-up because it has detected a LTPoE++ PSE. LTPoE++ PSEs can differentiate between a LTPoE++ PD and all other types of IEEE compliant PDs allowing LTPoE++ PSEs to remain compliant and interoperable with existing equipment.

LTC4290/LTC4271 Product Overview

The LTC4290/LTC4271 is a fourth generation 8-port PSE controller that implements eight PSE ports in either an endpoint or midspan design. Virtually all necessary circuitry is included to implement an IEEE 802.3at compliant PSE design, requiring only an external power MOSFET and sense resistor per channel; these minimize power loss compared to alternative designs with onboard MOSFETs and increase system reliability in the event a single channel fails.

All grades of the LTC4290/LTC4271 offer advanced fourth generation PSE features, including per-port current monitoring, V_{EE} monitoring, port current policing, one second current averaging and four general purpose input/output pins.

The LTC4290/LTC4271 chipset implements a proprietary isolation scheme for inter-chip communication. This architecture dramatically reduces BOM cost by replacing expensive opto-isolators and isolated power supplies with a single low-cost transformer.

The LTC4290/LTC4271 comes in three grades which support different PD power levels.

The A-grade LTC4290/LTC4271 chipset extends PoE power delivery capabilities to LTPoE++ levels. LTPoE++ is a Linear Technology proprietary specification allowing for the delivery of up to 90W to LTPoE++ compliant PDs. The LTPoE++ architecture extends the IEEE physical power negotiation to include 38.7W, 52.7W, 70W and 90W power levels. The A-grade LTC4290/LTC4271 also incorporates all B- and C-grade features.

The B-grade LTC4290/LTC4271 is a fully IEEE-compliant Type 2 PSE supporting autonomous detection, classification and powering of Type 1 and Type 2 PDs. The B-grade LTC4290/LTC4271 also incorporates all C-grade features.

The C-grade LTC4290/LTC4271 is a fully autonomous 802.3af Type 1 PSE solution. Intended for use only with the AUTO pin tied high, the C-grade chipset autonomously supports detection, classification and powering of Type 1 PDs. As a Type 1 PSE, two event classification is prohibited and Class 4 PDs are automatically treated as Class 0 PDs.

APPLICATIONS INFORMATION

PoE BASICS

Common Ethernet data connections consist of two or four twisted pairs of copper wire (commonly known as CAT-5 cable), transformer-coupled at each end to avoid ground loops. PoE systems take advantage of this coupling arrangement by applying voltage between the center-taps of the data transformers to transmit power from the PSE to the PD without affecting data transmission. Figure 10 shows a high level PoE system schematic.

To avoid damaging legacy data equipment that does not expect to see DC voltage, the PoE spec defines a protocol that determines when the PSE may apply and remove power. Valid PDs are required to have a specific 25k common-mode resistance at their input. When such a PD is connected to the cable, the PSE detects this signature resistance and turns on the power. When the PD is later disconnected, the PSE senses the open circuit and turns power off. The PSE also turns off power in the event of a current fault or short circuit.

When a PD is detected, the PSE optionally looks for a classification signature that tells the PSE the maximum power the PD will draw. The PSE can use this information to allocate power among several ports, to police the current consumption of the PD, or to reject a PD that will

draw more power than the PSE has available. The classification step is optional; if a PSE chooses not to classify a PD, it must assume that the PD is a 13W (full 802.3af power) device.

New in 802.3at

The newer 802.3at standard supersedes 802.3af and brings several new features:

- A PD may draw as much as 25.5W. Such PDs (and the PSEs that support them) are known as Type 2. Older 13W 802.3af equipment is classified as Type 1. Type 1 PDs will work with all PSEs; Type 2 PDs may require Type 2 PSEs to work properly. The LTC4290/LTC4271 is designed to work in both Type 1 and Type 2 PSE designs, and also supports non-standard configurations at higher power levels.
- The Classification protocol is expanded to allow Type 2 PSEs to detect Type 2 PDs, and to allow Type 2 PDs to determine if they are connected to a Type 2 PSE. Two versions of the new Classification protocol are available: an expanded version of the 802.3af Class Pulse protocol, and an alternate method integrated with the existing LLDP protocol (using the Ethernet

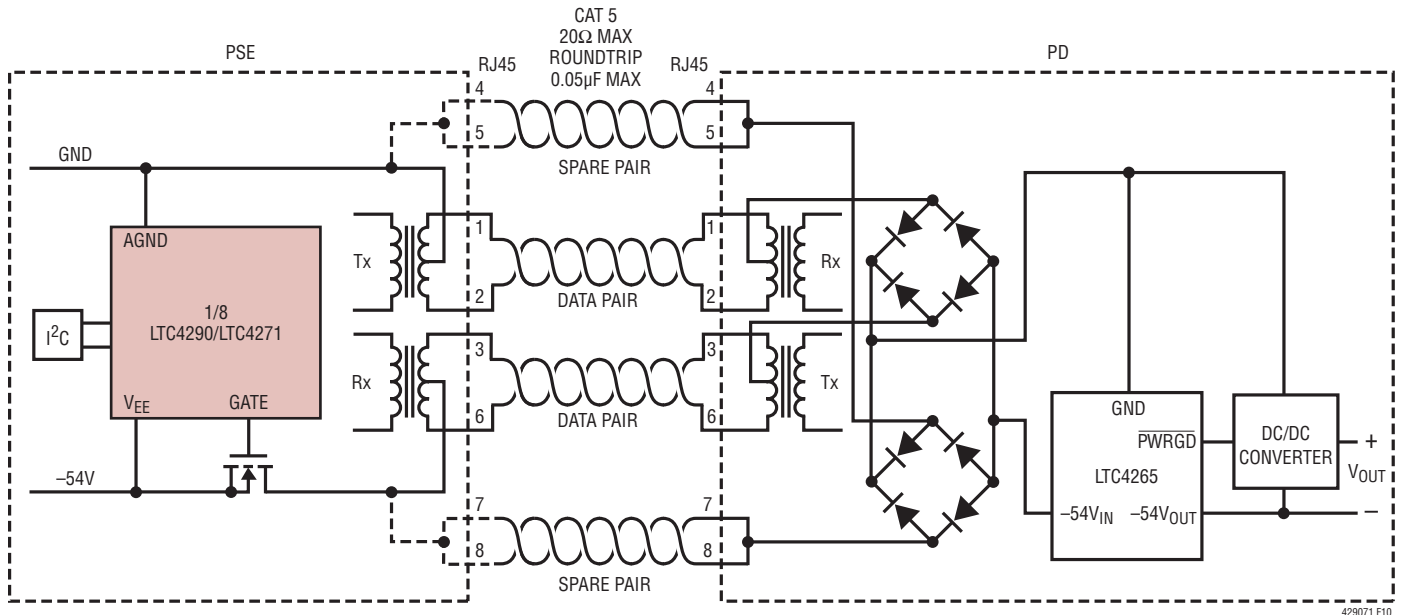

Figure 10. Power Over Ethernet System Diagram

429071 F10

429071fb

APPLICATIONS INFORMATION

data path). The LTC4290/LTC4271 fully supports the new Class Pulse protocol and is also compatible with the LLDP protocol (which is implemented in the data communications layer, not in the PoE circuitry).

- Fault protection current levels and timing are adjusted to reduce peak power in the MOSFET during a fault; this allows the new 25.5W power levels to be reached using the same MOSFETs as older 13W designs.

Extended Power LTPoE++

A-grade LTC4290/LTC4271 parts add the capability to autonomously deliver up to 90W of power to the PD. LTPoE++ PDs may forgoe 802.3 LLDP support and rely solely on the LTPoE++ Physical Classification to negotiate power with LTPoE++ PSEs; this greatly simplifies high-power PD implementations.

LTPoE++ may be optionally enabled for A-grade LTC4290/LTC4271s by setting both the High Power Enable and LTPoE++ Enable bits.

The higher levels of LTPoE++ delivery impose additional layout and component selection constraints. LTC4290 pin selects allow the AUTO pin mode LTC4271 to autonomously power up to supported power levels. If the AUTO pin is high, the XIO1 and XIO0 pins are sampled at reset to determine the maximum deliverable power. PDs requesting more than the available power limits are not powered.

Table 1. LTPoE++ AUTO Pin Mode Maximum Delivered Power Capabilities

POWER	XIO1	XIO0
38.7W	0	0
52.7W	0	1
70W	1	0
90W	1	1

BACKWARD COMPATIBILITY

The LTC4290/LTC4271 chipset is designed to be backward compatible with the LTC4266, operating in Type 2 mode, without software changes; only minor layout changes are required to implement a fully compliant IEEE 802.3at design.

Some LTC4266 registers have been obsoleted in the LTC4290/LTC4271 chipset. The obsoleted registers are not required for 802.3at compliant PSE operation. For more details about software differences between the LTC4266 and LTC4290/LTC4271, refer to the LTC4271 Software Programming document.

Operation with high power mode disabled is obsoleted in the LTC4290/LTC4271 chipset. All operations previously available in low power mode are fully implemented as a subset of the high power mode capabilities.

OPERATING MODES

The LTC4290/LTC4271 includes eight independent ports, each of which can operate in one of four modes: manual, semi-auto, AUTO pin, or shutdown.

Table 2. Operating Modes

MODE	AUTO PIN	OPMD	DETECT/CLASS	POWER-UP	AUTOMATIC I _{CUT} /I _{LIM} ASSIGNMENT
AUTO Pin	1	11b	Enabled at Reset	Automatically	Yes
Reserved	0	11b	N/A	N/A	N/A
Semi-auto	0	10b	Host Enabled	Upon Request	No
Manual	0	01b	Once Upon Request	Upon Request	No
Shutdown	0	00b	Disabled	Disabled	No

In manual mode, the port waits for instructions from the host system before taking any action. It runs a single detection or classification cycle when commanded to by the host, and reports the result in its Port Status register. The host system can command the port to turn on or off the power at any time.

In semi-auto mode, the port repeatedly attempts to detect and classify any PD attached to it. It reports the status of these attempts back to the host, and waits for a command from the host before turning on power to the port. The host must enable detection (and optionally classification) for the port before detection will start.

APPLICATIONS INFORMATION

AUTO pin mode operates the same as semi-auto mode except it will automatically turn on the power to the port if detection is successful. AUTO pin mode will autonomously set the I_{CUT} and I_{LIM} values based on the class result. This operational mode is only valid if the AUTO pin is high at reset or power-up and remains high during operation.

In shutdown mode, the port is disabled and will not detect or power a PD.

Regardless of which mode it is in, the LTC4290/LTC4271 will remove power automatically from any port that generates a current limit fault. It will also automatically remove power from any port that generates a disconnect event if disconnect detection is enabled. The host controller may also command the port to remove power at any time.

Reset and the AUTO/MID Pins

The initial LTC4290/LTC4271 configuration depends on the state of the AUTO and MID pins during reset. Reset occurs at power-up, or whenever the \overline{RESET} pin is pulled low or the global Reset All bit is set. Changing the state of AUTO or MID after power-up will not properly change the port behavior of the LTC4290/LTC4271 until a reset occurs.

Although typically used with a host controller, the LTC4290/LTC4271 can also be used in a standalone mode with no connection to the serial interface. If there is no host present, the AUTO pin must be tied high so that, at reset, all ports will be configured to operate automatically. Each port will detect and classify repeatedly until a PD is discovered, set I_{CUT} and I_{LIM} according to the classification results, apply power to valid PDs, and remove power when a PD is disconnected.

Table 3 shows the I_{CUT} and I_{LIM} values that will be automatically set in standalone (AUTO pin) mode, based on the discovered class.

Table 3. I_{CUT} and I_{LIM} Values in Standalone Mode

CLASS	I_{CUT}	I_{LIM}
Class 1	112mA	425mA
Class 2	206mA	425mA
Class 3 or 0	375mA	425mA
Class 4	638mA	850mA

The automatic setting of I_{CUT} and I_{LIM} values only occurs if the LTC4290/LTC4271 is reset with the AUTO pin high.

If the standalone application is a midspan, the MID pin must be tied high to enable correct midspan detection timing.

DETECTION

Detection Overview

To avoid damaging network devices that were not designed to tolerate DC voltage, a PSE must determine whether the connected device is a real PD before applying power. The IEEE specification requires that a valid PD have a common-mode resistance of $25k \pm 5\%$ at any port voltage below 10V. The PSE must accept resistances that fall between 19k and 26.5k, and it must reject resistances above 33k or below 15k (shaded regions in Figure 11). The PSE may choose to accept or reject resistances in the undefined areas between the must-accept and must-reject ranges. In particular, the PSE must reject standard computer network ports, many of which have 150Ω common-mode termination resistors that will be damaged if power is applied to them (the black region at the left of Figure 11).

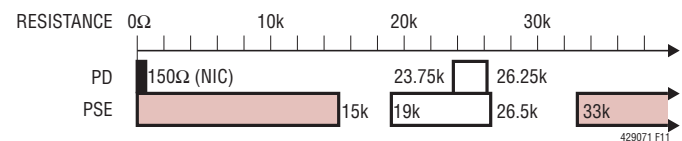

Figure 11. IEEE 802.3af Signature Resistance Ranges

4-Point Detection

The LTC4290/LTC4271 uses a 4-point detection method to discover PDs. False-positive detections are minimized by checking for signature resistance with both forced-current and forced-voltage measurements.

Initially, two test currents are forced onto the port (via the OUTn pin) and the resulting voltages are measured. The detection circuitry subtracts the two V-I points to determine the resistive slope while removing offset caused by series diodes or leakage at the port (see Figure 12). If the forced-current detection yields a valid signature resistance, two test voltages are then forced onto the port and the resulting currents are measured and subtracted. Both methods

APPLICATIONS INFORMATION

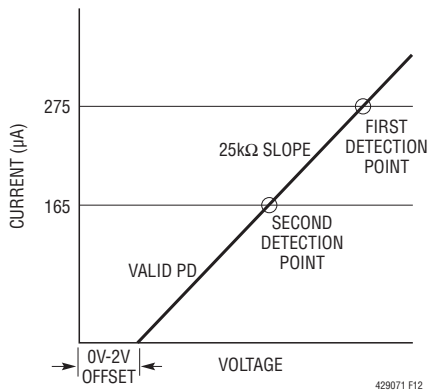

Figure 12. PD Detection

must report valid resistances for the port to report a valid detection. PD signature resistances between 17k and 29k (typically) are detected as valid and reported as Detect Good in the corresponding Port Status register. Values outside this range, including open and short circuits, are also reported. If the port measures less than 1V at the first forced-current test, the detection cycle will abort and Short Circuit will be reported. Table 4 shows the possible detection results.

Table 4. Detection Status

MEASURED PD SIGNATURE	DETECTION RESULT
Incomplete or Not Yet Tested	Detect Status Unknown
< 2.4k	Short Circuit
Capacitance > 2.7µF	C _{PD} too High
2.4k < R _{PD} < 17k	R _{SIG} too Low
17k < R _{PD} < 29k	Detect Good
> 29k	R _{SIG} too High
> 50k	Open Circuit
Voltage > 10V	Port Voltage Outside Detect Range

More on Operating Modes

The port's operating mode determines when the LTC4290/LTC4271 runs a detection cycle. In manual mode, the port will idle until the host orders a detect cycle. It will then run detection, report the results, and return to idle to wait for another command.

In semi-auto mode, the LTC4290/LTC4271 autonomously polls a port for PDs, but it will not apply power until commanded to do so by the host. The Port Status register is updated at the end of each detection cycle.

If a valid signature resistance is detected and classification is enabled, the port will classify the PD and report that result as well. The port will then wait for at least 100ms (or 2 seconds if midspan mode is enabled), and will repeat the detection cycle to ensure that the data in the Port Status register is up-to-date.

If the port is in semi-auto mode and high power operation is enabled, the port will not turn on in response to a power-on command unless the current detect result is detect good. Any other detect result will generate a t_{START} fault if a power-on command is received. In high power mode the port must be placed in manual mode to force a port on regardless of detect outcome.

Behavior in AUTO pin mode is similar to semi-auto; however, after detect good is reported and the port is classified (if classification is enabled), it is automatically powered on without further intervention. In standalone (AUTO pin) mode, the I_{CUT} and I_{LIM} thresholds are automatically set; see the Reset and the AUTO/MID Pins section for more information.

The signature detection circuitry is disabled when the port is initially powered up with the AUTO pin low, in shutdown mode, or when the corresponding Detect Enable bit is cleared.

Detection of Legacy PDs

Proprietary PDs that predate the original IEEE 802.3af standard are commonly referred to today as legacy devices. One type of legacy PD uses a large common-mode capacitance (>10µF) as the detection signature. Note that PDs in this range of capacitance are defined as invalid, so a PSE that detects legacy PDs is technically noncompliant with the IEEE spec. The LTC4290/LTC4271 can be configured to detect this type of legacy PD. Legacy detection is disabled by default, but can be manually enabled on a per-port basis. When enabled, the port will report Detect Good when it sees either a valid IEEE PD or a high-capacitance legacy PD. With legacy mode disabled, only valid IEEE PDs will be recognized.

APPLICATIONS INFORMATION

CLASSIFICATION

802.3af Classification

A PD may optionally present a classification signature to the PSE to indicate the maximum power it will draw while operating. The IEEE specification defines this signature as a constant current draw when the PSE port voltage is in the V_{CLASS} range (between 15.5V and 20.5V), with the current level indicating one of 5 possible PD classes. Figure 13 shows a typical PD load line, starting with the slope of the 25k signature resistor below 10V, then transitioning to the classification signature current (in this case, Class 3) in the V_{CLASS} range. Table 5 shows the possible classification values.

Table 5. 802.3af and 802.3at Classification Values

CLASS	RESULT
Class 0	No Class Signature Present; Treat Like Class 3
Class 1	3W
Class 2	7W
Class 3	13W
Class 4	25.5W (Type 2)

If classification is enabled, the port will classify the PD immediately after a successful detection cycle in semi-auto or AUTO pin modes, or when commanded to in manual mode. It measures the PD classification signature by applying 18V for 12ms (both values typical) to the port via the OUTn pin and measuring the resulting current; it then reports the discovered class in the Port Status register.

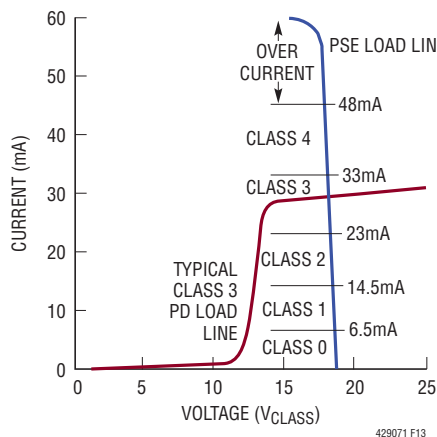

Figure 13. PD Classification

If the LTC4290/LTC4271 is in AUTO pin mode, it will additionally use the classification result to set the I_{CUT} and I_{LIM} thresholds. See the Reset and the AUTO/MID Pin section for more information.

The classification circuitry is disabled when the port is initially powered up with the AUTO pin low, in shutdown mode, or when the corresponding Class Enable bit is cleared.

802.3at 2-Event Classification

The 802.3at specification defines two methods of classifying a Type 2 PD. A-grade and B-grade LTC4290/LTC4271 parts support 802.3at 2-event classification.

One method adds extra fields to the Ethernet LLDP data protocol; although the LTC4290/LTC4271 is compatible with this classification method, it cannot perform classification directly since it doesn't have access to the data path. LLDP classification requires the PSE to power the PD as a standard 802.3af (Type 1) device. It then waits for the host to perform LLDP communication with the PD and update the PSE port data. The LTC4290/LTC4271 supports changing the I_{LIM} and I_{CUT} levels on the fly, allowing the host to complete LLDP classification.

The second 802.3at classification method, known as 2-event classification or ping-pong, is supported by the LTC4290/LTC4271. A Type 2 PD that is requesting more than 13W will indicate Class 4 during normal 802.3af classification. If the LTC4290/LTC4271 sees Class 4, it forces the port to a specified lower voltage (called the mark voltage, typically 9V), pauses briefly, and then re-runs classification to verify the Class 4 reading (Figure 1). It also sets a bit in the High Power Status register to indicate that it ran the second classification cycle. The second cycle alerts the PD that it is connected to a Type 2 PSE which can supply Type 2 power levels.

2-event ping-pong classification is enabled by setting a bit in the port's High Power Mode register. Note that a ping-pong enabled port only runs the second classification cycle when it detects a Class 4 device; if the first cycle returns Class 0 to 3, the port determines it is connected to a Type 1 PD and does not run the second classification cycle.

APPLICATIONS INFORMATION

Invalid Type 2 Class Combinations

The 802.3at specification defines a Type 2 PD class signature as two consecutive Class 4 results; a Class 4 followed by a Class 0-3 is not a valid signature. In AUTO pin mode, the LTC4290/LTC4271 will power a detected PD regardless of the classification results, with one exception: if the PD presents an invalid Type 2 signature (Class 4 followed by Class 0 to 3), the LTC4290/LTC4271 will not provide power and will restart the detection process. To aid in diagnosis, the Port Status register will always report the results of the last class pulse, so an invalid Class 4–Class 2 combination would report a second class pulse was run in the High Power Status register (which implies that the first cycle found class 4), and Class 2 in the Port Status register.

POWER CONTROL

The primary function of the LTC4290/LTC4271 is to control the delivery of power to the PSE port. It does this by controlling the gate drive voltage of an external power MOSFET while monitoring the current via an external sense resistor and the output voltage at the OUT pin. This circuitry serves to couple the raw V_{EE} input supply to the port in a controlled manner that satisfies the PDs power needs while minimizing both power dissipation in the MOSFET and disturbances on the V_{EE} backplane.

Inrush Control

Once the command has been given to turn on a port, the LTC4290/LTC4271 ramps up the GATE pin of that port's external MOSFET in a controlled manner. Under normal power-up circumstances, the MOSFET gate will rise until the port current reaches the inrush current limit level (typically 425mA), at which point the GATE pin will be servoed to maintain the specified I_{INRUSH} current. During this inrush period, a timer (t_{START}) runs. When output charging is complete, the port current will fall and the GATE pin will be allowed to continue rising to fully enhance the MOSFET and minimize its on-resistance. The final V_{GS} is

nominally 12V. The inrush period is maintained until the t_{START} timer expires. At this time if the inrush current limit level is still exceeded, the port will be turned back off and a t_{START} fault reported.

Current Limit

Each LTC4290/LTC4271 port includes two current limiting thresholds (I_{CUT} and I_{LIM}), each with a corresponding timer (t_{CUT} and t_{LIM}). Setting the I_{CUT} and I_{LIM} thresholds depends on several factors: the class of the PD, the voltage of the main supply (V_{EE}), the type of PSE (Type 1 or Type 2), the sense resistor (0.5Ω or 0.25Ω), the SOA of the MOSFET, and whether or not the system is required to enforce class current levels.

Per the IEEE specification, the LTC4290/LTC4271 will allow the port current to exceed I_{CUT} for a limited period of time before removing power from the port, whereas it will actively control the MOSFET gate drive to keep the port current below I_{LIM} . The port does not take any action to limit the current when only the I_{CUT} threshold is exceeded, but does start the t_{CUT} timer. If the current drops below the I_{CUT} current threshold before its timer expires, the t_{CUT} timer counts back down, but at 1/16 the rate that it counts up. If the t_{CUT} timer reaches 60ms (typical) the port is turned off and the port t_{CUT} fault is set. This allows the current limit circuitry to tolerate intermittent overload signals with duty cycles below about 6%; longer duty cycle overloads will turn the port off.

The I_{LIM} current limiting circuit is always enabled and actively limiting port current. The t_{LIM} timer is enabled only when the t_{LIM} Enable bit is set. This allows t_{LIM} to be set to a shorter value than t_{CUT} to provide more aggressive MOSFET protection and turn off a port before MOSFET damage can occur. The t_{LIM} timer starts when the I_{LIM} threshold is exceeded. When the t_{LIM} timer reaches 12ms (typical) the port is turned off and the port t_{LIM} fault is set. When the t_{LIM} Enable bit is disabled t_{LIM} behaviors are tracked by the t_{CUT} timer, which counts up during both I_{LIM} and I_{CUT} events.

APPLICATIONS INFORMATION

I_{CUT} is typically set to a lower value than I_{LIM} to allow the port to tolerate minor faults without current limiting.

Per the IEEE specification, the LTC4290/LTC4271 will automatically set I_{LIM} to 425mA (shown in bold in Table 6) during inrush at port turn-on, and then switch to the programmed I_{LIM} setting once inrush has completed. To maintain IEEE compliance, I_{LIM} should be kept at 425mA for all Type 1 PDs, and 850mA if a Type 2 PD is detected. I_{LIM} is automatically reset to 425mA when a port turns off.

Table 6. Example Current Limit Settings

I_{LIM} (mA)	INTERNAL REGISTER SETTING (hex)	
	$R_{\text{SENSE}} = 0.5\Omega$	$R_{\text{SENSE}} = 0.25\Omega$
53	88	
106	08	88
159	89	
213	80	08
266	8A	
319	09	89
372	8B	
425	00	80
478	8E	
531	92	8A
584	CB	
638	10	90
744	D2	9A
850	40	C0
956	4A	CA
1063	50	D0
1169	5A	DA
1275	60	E0
1488	52	49
1700		40
1913		4A
2125		50
2338		5A
2550		60
2975		52

I_{LIM} Foldback

The LTC4290/LTC4271 features a two-stage foldback circuit that reduces the port current if the port voltage falls below the normal operating voltage. This keeps MOSFET power dissipation at safe levels for typical 802.3af MOSFETs, even at extended 802.3at power levels. Current limit and foldback behavior are programmable on a per-port basis.

Table 6 gives examples of recommended I_{LIM} register settings.

The LTC4290/LTC4271 will support current levels well beyond the maximum values in the 802.3at specification. The shaded areas in Table 6 indicate settings that may require a larger external MOSFET, additional heat sinking, or setting t_{LIM} Enable.

MOSFET Fault Detection

LTC4290/LTC4271 PSE ports are designed to tolerate significant levels of abuse, but in extreme cases it is possible for the external MOSFET to be damaged. A failed MOSFET may short source to drain, which will make the port appear to be on when it should be off; this condition may also cause the sense resistor to fuse open, turning off the port but causing the LTC4290 SENSE pin to rise to an abnormally high voltage. A failed MOSFET may also short from gate to drain, causing the LTC4290 GATE pin to rise to an abnormally high voltage. The LTC4290 OUT, SENSE and GATE pins are designed to tolerate up to 80V faults without damage.

If the LTC4290/LTC4271 sees any of these conditions for more than 180 μ s, it disables all port functionality, reduces the gate drive pull-down current for the port and reports a FET Bad fault. This is typically a permanent fault, but the host can attempt to recover by resetting the port, or by resetting the entire chip if a port reset fails to clear the fault. If the MOSFET is in fact bad, the fault will quickly return, and the port will disable itself again. The remaining ports of the LTC4290/LTC4271 are unaffected.

An open or missing MOSFET will not trigger a FET Bad fault, but will cause a t_{START} fault if the LTC4290/LTC4271 attempts to turn on the port.

APPLICATIONS INFORMATION

Port Current Readback

The LTC4290/LTC4271 measures the current at each port with an internal A/D converter. Port data is only valid when the port power is on and reads zero at all other times. The converter has two modes:

- 100ms mode: Samples are taken continuously and the measured value is updated every 100ms
- 1s mode: Samples are taken continuously; a moving 1 second average is updated every 100ms

Port Current Policing

The LTC4290/LTC4271 can augment t_{CUT} current monitoring with a policing function to track the one second current averages. A port violating the user-specified Port Police Threshold will be shut off with both a t_{CUT} and Police event recorded. A port current Police event can be differentiated from a port t_{CUT} violation by reading both events bits; both bits are set for a Police violation while only the t_{CUT} bit is set for t_{CUT} timer violations.

Port Voltage Readback

The LTC4290/LTC4271 measures the output voltage at each port with an internal A/D converter. Port data is only valid when the port power is on and reads zero at all other times.

Disconnect

The LTC4290/LTC4271 monitors powered ports to ensure the PD continues to draw the minimum specified current. A disconnect timer counts up whenever port current is below 7.5mA (typ), indicating that the PD has been disconnected. If the t_{DIS} timer expires, the port will be turned off and the disconnect bit in the fault event register will be set. If the current returns before the t_{DIS} timer runs out, the timer resets. As long as the PD exceeds the minimum current level more often than t_{DIS} , it will remain powered.

Although not recommended, the DC disconnect feature can be disabled by clearing the corresponding enable bits. Note that this defeats the protection mechanisms built into the IEEE specification, since a powered port will stay powered after the PD is removed. If the still-powered port is subsequently connected to a non-PoE data device, the device may be damaged.

The LTC4290/LTC4271 does not include AC disconnect circuitry, but includes AC Disconnect Enable bits to maintain compatibility with the LTC4259A. If the AC Disconnect Enable bits are set, DC disconnect will be used.

Masked Shutdown

The LTC4290/LTC4271 provides a low latency port shedding feature to quickly reduce the system load when required. By allowing a pre-determined set of ports to be turned off, the current on an overloaded main power supply can be reduced rapidly while keeping high priority devices powered. Each port can be configured to high or low priority; all low-priority ports will shut down within 6.5 μ s after the $\overline{\text{MSD}}$ pin is pulled low, high priority ports will remain powered. If a port is turned off via $\overline{\text{MSD}}$, the corresponding Detection and Classification Enable bits are cleared, so the port will remain off until the host explicitly re-enables detection.

In the LTC4290/LTC4271 chipset the active level of $\overline{\text{MSD}}$ is register configurable as active high or low. The default is LTC4266-compatible active low behavior.

V_{EE} Readback

The LTC4290/LTC4271 measures the V_{EE} voltage with an internal 12-bit A/D converter.

General Purpose IO

Two sets of general purpose IO pins are available in the LTC4290/LTC4271 chipset. The first set of general purpose IO are GP1 and GP0. These fully bidirectional IO are 3.3V CMOS IO on the LTC4271 chip.

APPLICATIONS INFORMATION

The second set of general purpose IO pins are XIO1 and XIO0. These fully bidirectional IO are 4.3V CMOS IO on the LTC4290 chip.

Code Download

LTC4271 firmware is field-upgradable by downloading and executing RAM images. RAM images are volatile and must be re-downloaded after each V_{DD} power cycle, but will remain valid during reset and V_{EE} power events. Contact Linear Technology for code download procedures and RAM images.

SERIAL DIGITAL INTERFACE

Overview

The LTC4290/LTC4271 communicates with the host using a standard SMBus/I²C 2-wire interface. The LTC4290/LTC4271 is a slave-only device, and communicates with the host master using the standard SMBus protocols. Interrupts are signaled to the host via the \overline{INT} pin. The Timing Diagrams (Figures 5 through 9) show typical communication waveforms and their timing relationships. More information about the SMBus data protocols can be found at www.smbus.org.

The LTC4290/LTC4271 requires both the V_{DD} and V_{EE} supply rails to be present for the serial interface to function.

Bus Addressing

The LTC4290/LTC4271's primary 7-bit serial bus address is $A_610A_3A_2A_1A_0b$, with bit 6 controlled by AD6 and the lower four bits set by the AD3-AD0 pins; this allows up to 16 LTC4290/LTC4271s, on a single bus. Sixteen LTC4290/LTC4271 are equivalent to 32 quad PSEs or 128 ports. All LTC4290/LTC4271s also respond to the broadcast address 0110000b, allowing the host to write the same command (typically configuration commands) to multiple LTC4290/LTC4271s in a single transaction. If the LTC4290/LTC4271

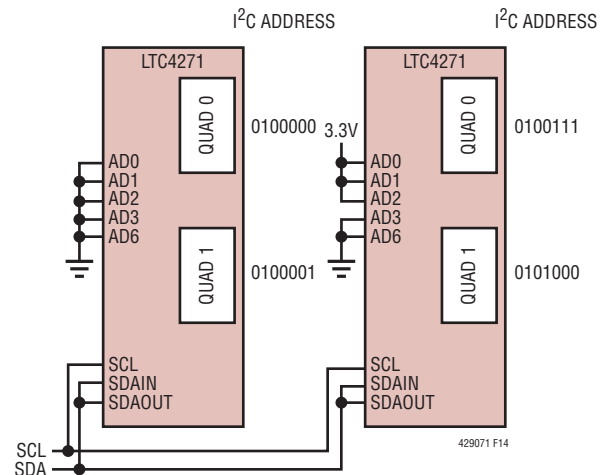

Figure 14. Example I²C Bus Addressing

is asserting the \overline{INT} pin, it will also respond to the alert response address (0001100b) per the SMBus specification.

Each LTC4290/LTC4271 is logically composed of two quads of four ports each. Each quad occupies separate, contiguous I²C addresses. The AD6, AD3-0 pins set the address of the base quad while the second quad is consecutively numbered. I²C addresses outside of the $x10xxxxb$ range are considered illegal and will not respond. Each internal quad is independent of the other quad, with the exception of writes to the Chip Reset, \overline{MSD} Inversion and General Purpose Input Output registers. These registers are global in nature and will affect all quads.

Interrupts and SMBAlert

Most LTC4290/LTC4271 port events can be configured to trigger an interrupt, asserting the \overline{INT} pin and alerting the host to the event. This removes the need for the host to poll the LTC4290/LTC4271, minimizing serial bus traffic and conserving host CPU cycles. Multiple LTC4290/LTC4271s can share a common \overline{INT} line, with the host using the SMBAlert protocol (ARA) to determine which LTC4290/LTC4271 caused an interrupt.

APPLICATIONS INFORMATION

Register Description

For information on serial bus usage and device configuration and status, refer to the LTC4271 Software Programming documentation.

ISOLATION REQUIREMENTS

IEEE 802.3 Ethernet specifications require that network segments (including PoE circuitry) be electrically isolated from the chassis ground of each network interface device. However, network segments are not required to be isolated from each other, provided that the segments are connected to devices residing within a single building on a single power distribution system.

For simple devices such as small PoE switches, the isolation requirement can be met by using an isolated main power supply for the entire device. This strategy can be used if the device has no electrically conducting ports other than twisted-pair Ethernet. In this case, the SDAIN and SDAOUT pins can be tied together and will act as a standard I²C/SMBus SDA pin.

If the device is part of a larger system, contains additional external non-Ethernet ports, or must be referenced to protective ground for some other reason, the Power over Ethernet subsystem must be electrically isolated from the rest of the system.

The LTC4290/LTC4271 chipset simplifies PSE isolation by allowing the LTC4271 chip to reside on the non-isolated side. There it can receive power from the main logic supply and connect directly to the I²C/SMBus bus. Isolation between the LTC4271 and LTC4290 is implemented using a proprietary transformer-based communication protocol. Additional details are provided in the Serial Bus Isolation section of this data sheet.

EXTERNAL COMPONENT SELECTION

Power Supplies and Bypassing

The LTC4290/LTC4271 requires two supply voltages to operate. V_{DD} requires 3.3V (nominally) relative to DGND. V_{EE} requires a negative voltage of between $-45V$ and $-57V$ for Type 1 PSEs, $-51V$ to $-57V$ for Type 2 PSEs, or $-54.75V$ to $-57V$ for LTPoE++ PSEs, relative to AGND.

Digital Power Supply

V_{DD} provides digital power for the LTC4271 processor, and draws a maximum of 15mA. A ceramic decoupling cap of at least $0.1\mu F$ should be placed from V_{DD} to DGND, as close as practical to each LTC4271 chip. A 1.8V core voltage supply is generated internally and requires a $1\mu F$ ceramic decoupling cap between the CAP1 pin and DGND.

In the LTC4290/LTC4271, V_{DD} should be delivered by the host controller's non-isolated 3.3V supply. To maintain required isolation AGND and DGND must not be connected in any way.

Main PoE Power Supply

V_{EE} is the main isolated PoE supply that provides power to the PDs. Because it supplies a relatively large amount of power and is subject to significant current transients, it requires more design care than a simple logic supply. For minimum IR loss and best system efficiency, set V_{EE} near maximum amplitude (57V), leaving enough margin to account for transient over or undershoot, temperature drift, and the line regulation specifications of the particular power supply used.

Bypass capacitance between AGND and V_{EE} is very important for reliable operation. If a short circuit occurs at one of the output ports it can take as long as $1\mu s$ for the LTC4290 to begin regulating the current. During this time the current is limited only by the small impedances in the circuit and a high current spike typically occurs, causing a

APPLICATIONS INFORMATION

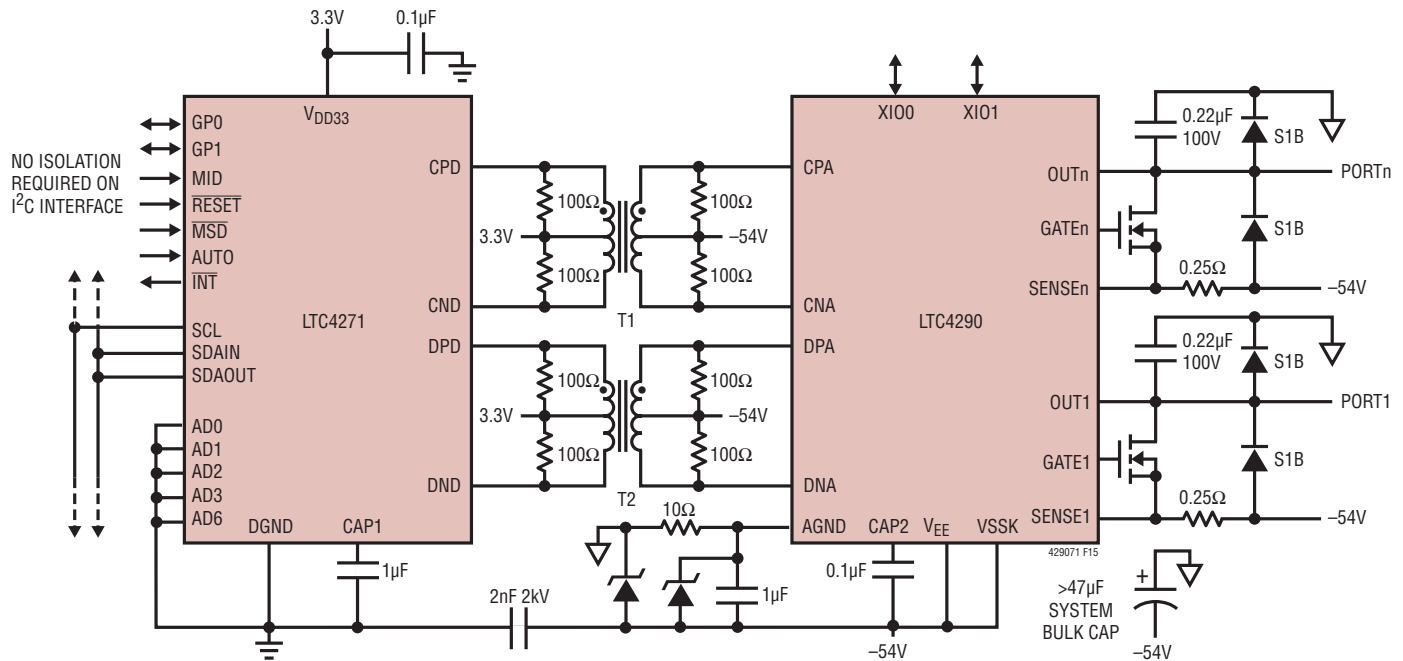

Figure 15. LTC4290/LTC4271 Proprietary Isolation

voltage transient on the V_{EE} supply and possibly causing the LTC4290/LTC4271 to reset due to a UVLO fault. A $1\mu\text{F}$, 100V X7R capacitor placed near the V_{EE} pin along with an electrolytic bulk capacitor of at least $47\mu\text{F}$ is recommended to minimize spurious resets.

Serial Bus Isolation

The LTC4290/LTC4271 chipset uses transformers to isolate the LTC4271 from the LTC4290. In this case, the SDAIN and SDAOUT pins can be shorted to each other and tied directly to the I²C/SMBus bus. The transformers should be 10BASE-T or 10/100BASE-T with a 1:1 turns ratio. It is important that the selected transformers do not have common-mode chokes. These transformers typically provide 1500V of isolation between the LTC4271 and the LTC4290. For proper operation strict layout guidelines must be met.

External MOSFET

Careful selection of the power MOSFET is critical to system reliability. LTC recommends either Fairchild IRFM120A, FDT3612, FDMC3612 or Philips PHT6NQ10T for their proven reliability in Type 1 and Type 2 PSE applications. SOA curves are not a reliable specification for MOSFET selection. Contact LTC Applications before using a MOSFET other than one of these recommended parts.

Sense Resistor

The LTC4290/LTC4271 is designed to use 0.25Ω current sense resistors to reduce power dissipation. Four commonly available 1Ω resistors (sized according to power dissipation) can be used in parallel in place of a single 0.25Ω resistor. In order to meet the I_{CUT} and I_{LIM} accuracy required by the IEEE specification, the sense resistors should have $\pm 1\%$ tolerance or better, and no more than $\pm 200\text{ppm}/^\circ\text{C}$ temperature coefficient. In addition, the sense resistors must meet strict layout guidelines.

TYPICAL APPLICATION

Complete 8-Port PSE

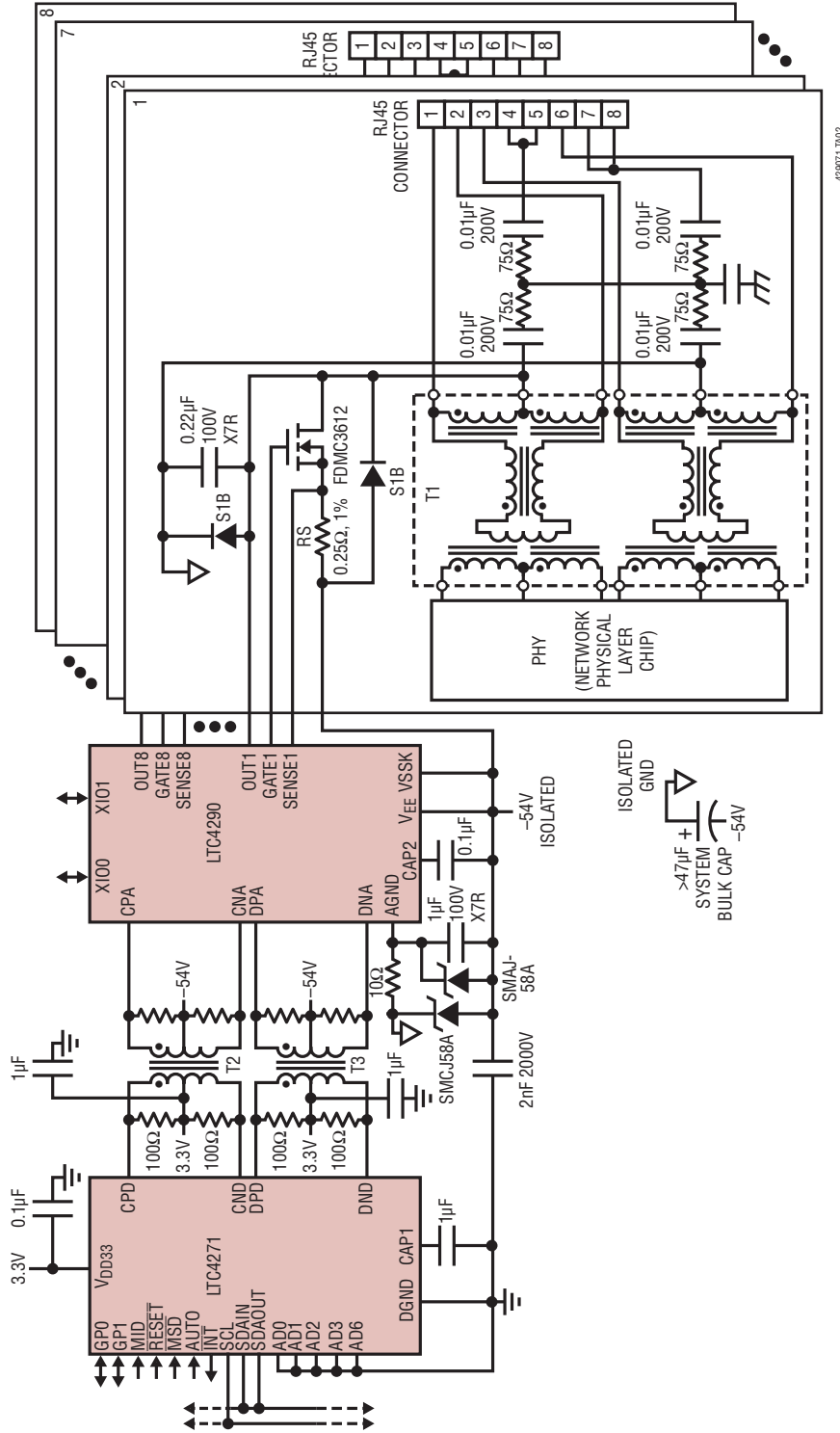

429071 TA02

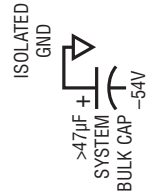

PACKAGE DESCRIPTION

Please refer to <http://www.linear.com/designtools/packaging/> for the most recent package drawings.

UF Package
24-Lead Plastic QFN (4mm × 4mm)
 (Reference LTC DWG # 05-08-1697)

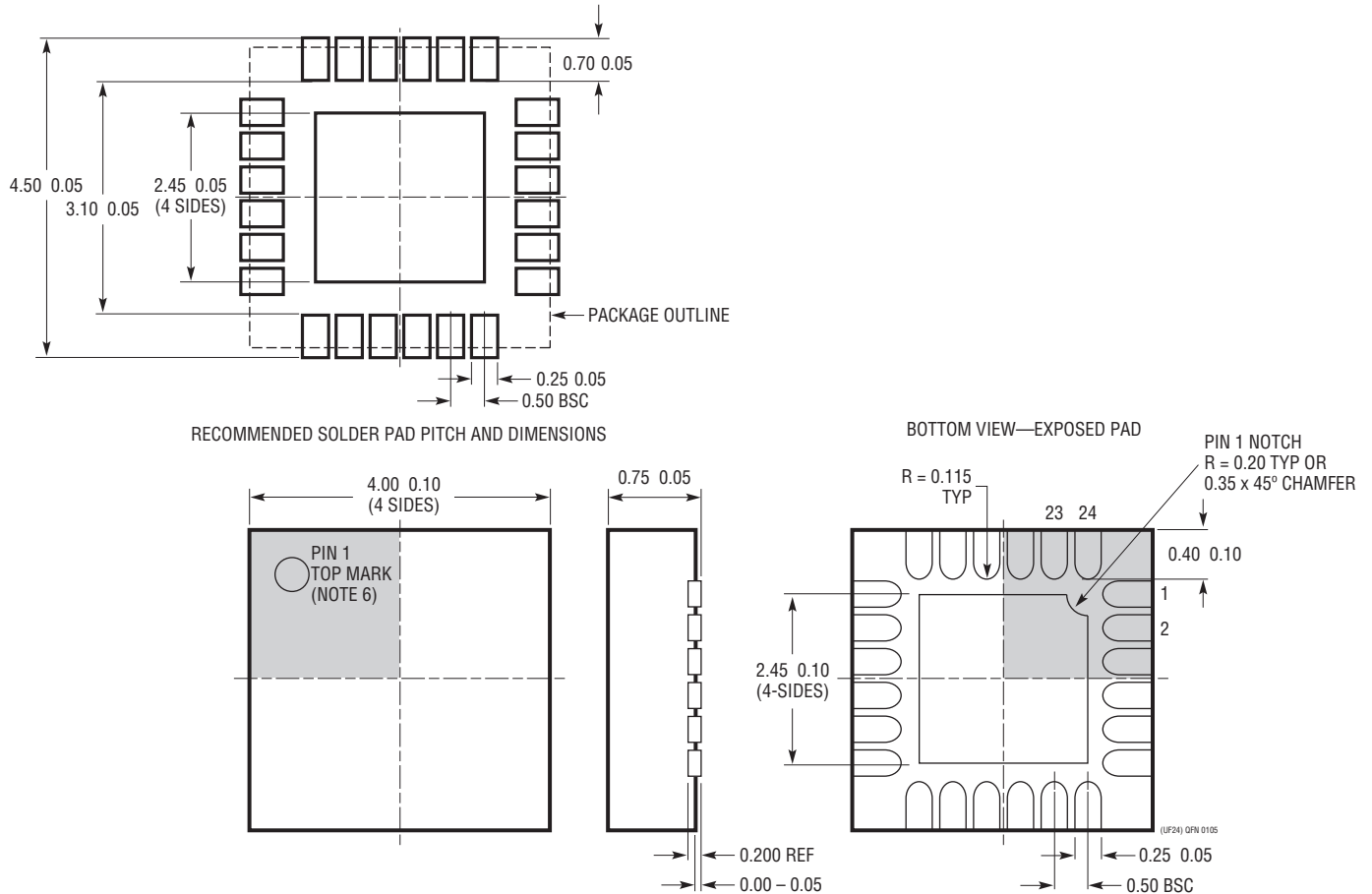

- NOTE:
1. DRAWING PROPOSED TO BE MADE A JEDEC PACKAGE OUTLINE MO-220 VARIATION (WGGD-X)—TO BE APPROVED
 2. DRAWING NOT TO SCALE
 3. ALL DIMENSIONS ARE IN MILLIMETERS
 4. DIMENSIONS OF EXPOSED PAD ON BOTTOM OF PACKAGE DO NOT INCLUDE MOLD FLASH. MOLD FLASH, IF PRESENT, SHALL NOT EXCEED 0.15mm ON ANY SIDE, IF PRESENT

5. EXPOSED PAD SHALL BE SOLDER PLATED
6. SHADED AREA IS ONLY A REFERENCE FOR PIN 1 LOCATION ON THE TOP AND BOTTOM OF PACKAGE

PACKAGE DESCRIPTION

Please refer to <http://www.linear.com/designtools/packaging/> for the most recent package drawings.

UJ Package
40-Lead Plastic QFN (6mm × 6mm)
 (Reference LTC DWG # 05-08-1728 Rev 0)

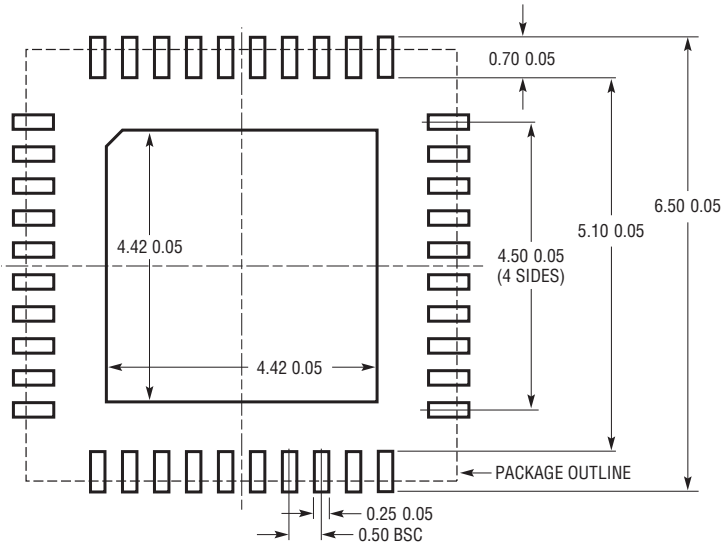

RECOMMENDED SOLDER PAD PITCH AND DIMENSIONS
 APPLY SOLDER MASK TO AREAS THAT ARE NOT SOLDERED

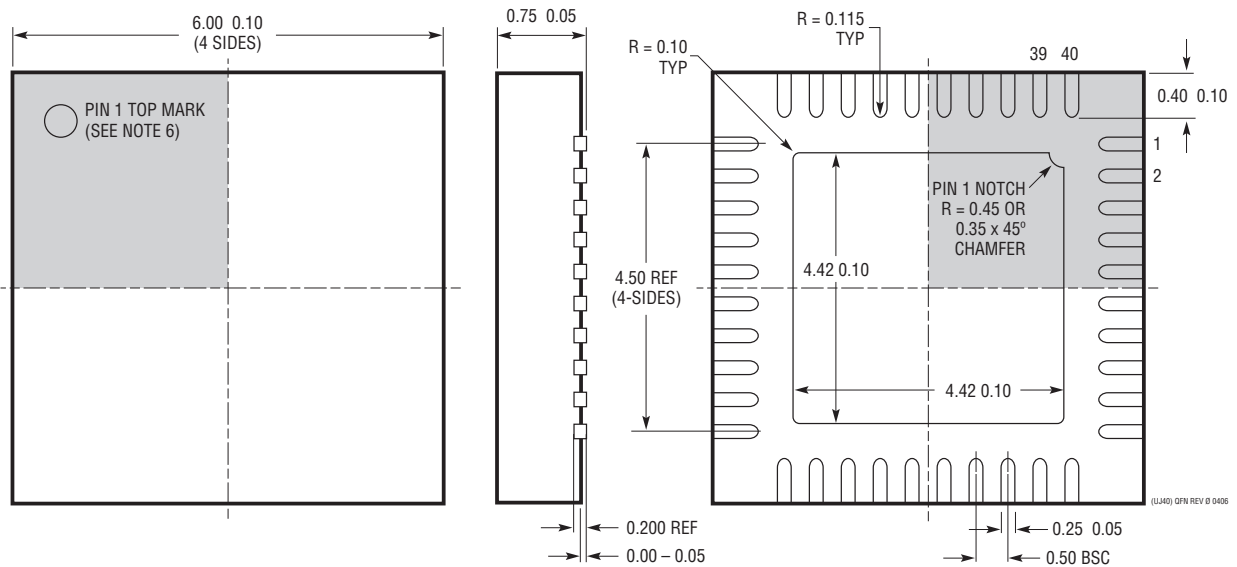

- NOTE:
1. DRAWING IS A JEDEC PACKAGE OUTLINE VARIATION OF (WJJD-2)
 2. DRAWING NOT TO SCALE
 3. ALL DIMENSIONS ARE IN MILLIMETERS
 4. DIMENSIONS OF EXPOSED PAD ON BOTTOM OF PACKAGE DO NOT INCLUDE MOLD FLASH. MOLD FLASH, IF PRESENT, SHALL NOT EXCEED 0.20mm ON ANY SIDE, IF PRESENT
 5. EXPOSED PAD SHALL BE SOLDER PLATED
 6. SHADED AREA IS ONLY A REFERENCE FOR PIN 1 LOCATION ON THE TOP AND BOTTOM OF PACKAGE

BOTTOM VIEW—EXPOSED PAD

REVISION HISTORY

REV	DATE	DESCRIPTION	PAGE NUMBER
A	4/13	Added A-grade and C-grade to entire data sheet	1 - 32
B	07/15	Updated surge protection recommendations Simplified Power over Ethernet system diagram	1, 26, 27, 28, 32 16

Mouser Electronics

Authorized Distributor

Click to View Pricing, Inventory, Delivery & Lifecycle Information:

[Analog Devices Inc.:](#)

[LTC4290CIUJ#TRPBF](#) [LTC4290BIUJ#PBF](#) [LTC4290AIUJ#PBF](#) [LTC4290AIUJ#TRPBF](#) [LTC4290BIUJ#TRPBF](#)
[LTC4290CIUJ#PBF](#) [DC1843B](#)